

**Profili e Sistemi innovativi**  
*Innovative Profiles and Systems*

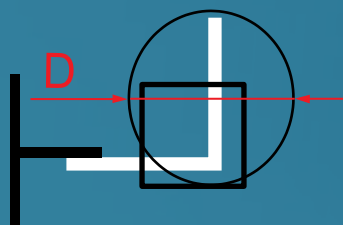

**SPECIAL  
PROFILES**



**Listino Prezzi 23/01**  
Price List 23/01

**2023**



## **Special Profiles**

Special Profiles nasce dal know how e dall'esperienza trentennale di Mecc.Al, azienda leader mondiale nella progettazione e produzione di Alluminio. Col nuovo brand "Special Profiles", realizza e distribuisce una gamma completa di profili e lamiere per i settori del Fai da Te, posa dei pavimenti e rivestimenti, sia a livello civile che industriale, in tutto il mondo.

## **Special Profiles**

*Special Profiles was born from the know-how and thirty year experience of Mecc.Al, a world leader in the design and production of aluminum. With the new brand "Special Profiles", it creates and distributes a complete range of profiles and metal sheets for the DIY sectors, laying floors and walls, both civil and industrial, worldwide.*



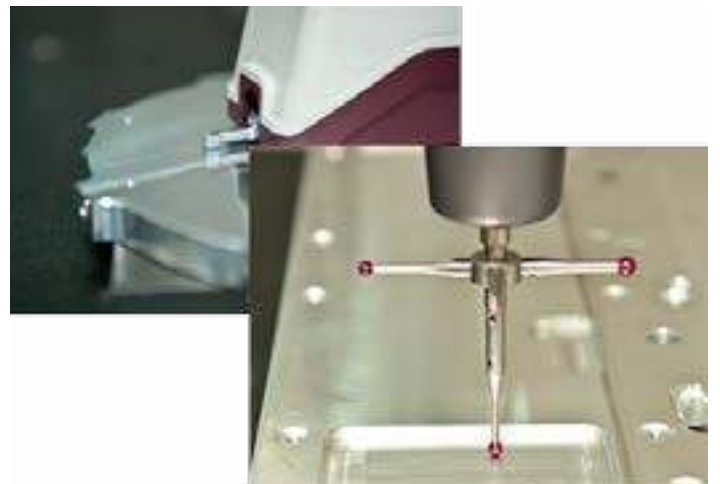

## Special Profiles

sfruttando le enormi risorse del Gruppo di appartenenza, parte dalle materie prime per produrre in autonomia tutti i semilavorati necessari per la produzione dei prodotti finiti. Qualità, Flessibilità, Affidabilità, Competitività sono alcuni dei vantaggi a Vostra disposizione.

*Using the huge resources of the Group to which it belongs, Special Profile starts from raw materials to independently produce all the semi-finished products necessary for the production of finished products. Quality, Availability, Flexibility, Reliability, are some of the advantages available to you.*

## Special Profiles

utilizza per la produzione dei prodotti macchine e sistemi di ultima generazione: anche tutti i trattamenti superficiali sono realizzati al suo interno. Un magazzino efficace ed efficiente, unitamente ad una logistica all'avanguardia, permettono consegne entro le 48 ore dall'ordine.

*Special Profiles entirely produces its products within the Company, guaranteeing Quality and Service. Thanks to the latest generation of machines and systems, all surface treatments are also carried out internally. An effective and efficient warehouse, together with cutting-edge logistics, allow deliveries within 48 hours.*





## Servizio Clienti

L'intero team Special Profiles è a Vostra completa disposizione per qualsiasi tipo di suggerimento e supporto. Grazie alla nostra rete capillare di agenti su tutto il territorio potete beneficiare di un immediato contatto professionale. Il tutto supportato anche dal nostro personale interno. Non esitate a contattarci, usando i nostri riferimenti.

## Customer Care

*The whole Special Profiles team is at your complete disposal for any suggestion and support. Thanks to our network of agents throughout the territory, you can benefit from immediate professional contact. All supported also by our internal staff. Do not hesitate to contact us, using our references.*



**Tel.** +39 0721 876 4205 (IT)

**Tel.** +39 0721 876 4206 (EN)

**E-Mail** [specialprofiles@meccal.com](mailto:specialprofiles@meccal.com)

**Web** [www.special-profiles.com](http://www.special-profiles.com)



**QUALITY SYSTEM  
CERTIFICATION  
DNV-GL  
ISO 9001**

**QUALITY SYSTEM  
CERTIFICATION  
DNV-GL  
IATF 16949**

**QUALITY SYSTEM  
CERTIFICATION  
DNV-GL  
ISO 14001**



## **Le certificazioni per la Qualità** Quality certifications

La ricerca della qualità in tutti gli aspetti della produzione è uno dei punti fondamentali di Special Profiles, certificata dall'ente internazionale DNV secondo la norma UNI EN ISO 9001:2015, grazie anche ad un'accurata politica di selezione e controllo rivolta verso i nostri partner e fornitori.

Un prodotto di alta qualità, affidabile ed esauriente, la capacità manifatturiera, il personale dedito e qualificato ed il rispetto rigoroso dei celeri tempi di consegna sono i punti di forza di Special Profiles, partner ideale per tutte le esigenze nell'ambito dei Profili per il fai da te, per le costruzioni, per la posa di pavimenti e rivestimenti.

Il nostro impegno nella qualità si rivolge allo stesso tempo al rispetto della salute umana ed ambientale, offrendo prodotti conformi alle direttive RoHS e REACH che limitano la presenza di sostanze pericolose nella produzione : la nostra certificazione ISO 14001 ne è la prova tangibile.

*The search for quality in all aspects of production is one of the fundamental points of Special Profiles, certified by the DNV international body, according to the UNI EN ISO 9001: 2015 standard, thanks also to an accurate selection and control policy aimed at our partners and suppliers. A high quality, reliable and comprehensive product, manufacturing capacity, dedicated and qualified staff and rigorous respect for fast delivery times are the strength of Special Profiles, the ideal partner for all needs in the field of Profiles for do-it-yourself, construction, for laying floors and walls.*

*Our commitment to quality is aimed at the same time to respect human and environmental health, offering products compliant with the RoHS and REACH directives which limit the presence of dangerous substances in production: our ISO 14001 certification is tangible proof of this.*

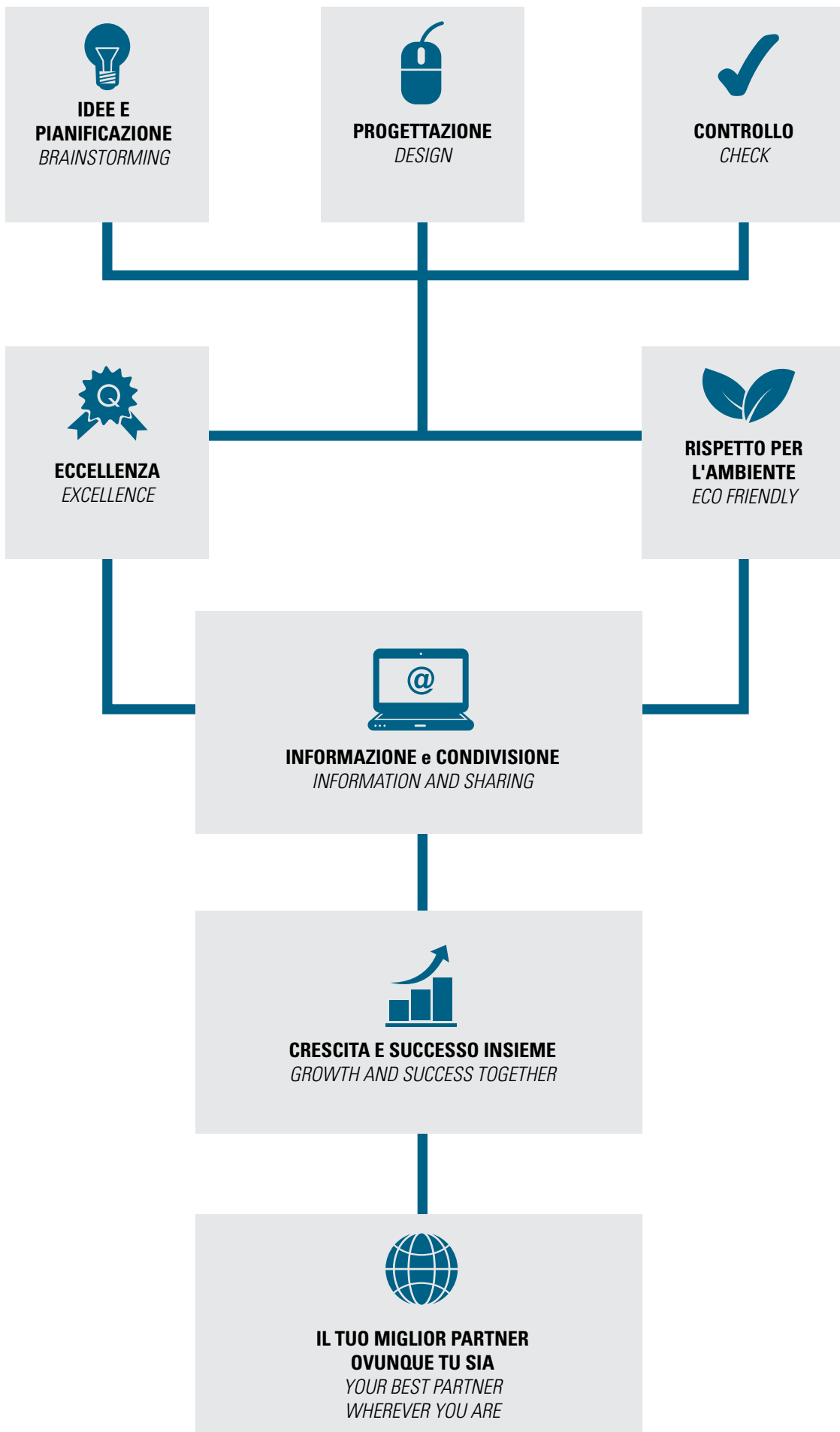

pag. 7

## **Profili per rivestimenti**

Profiles for wall covering



pag. 23

## **Profili per pavimenti**

Profiles for Floors



pag. 37

## **Profili per gradini**

Stair nosing profiles



pag. 39

## **Battiscopa** Skirting boards

pag. 41

## **Profili di raccordo igienici** Hygienic cove Profiles



pag. 47

## **Profili per balconi e terrazzi**

Edging Profiles for terraces and balconies



pag. 55

## **Sistemi di drenaggio**

Draining and shower systems



pag. 63

## **Giunti di dilatazione, Accessori per la posa**

Accessories for laying movement joints



pag. 69

## **Profili per il fai da te** DIY Profiles

Alluminio/Aluminium

pag. 89

Acciaio/Steel

pag. 93

Ferro/Iron

pag. 99

Lamiere/Sheets



pag. 105

## **Sistemi espositivi e proposte di Vendita**

Display systems and sales proposals



pag. 116

## **Imballi-Etichette-Materiali-Condizioni di vendita**

Packing-Labels-Materials-Terms of sale



SPECIAL  
PROFILES

## **Profili per Rivestimenti**

Profile for wall covering



**ALLUMINIO  
ANODIZZATO ARGENTO**  
 Silver Anodized Aluminium

**SPECIAL ROUND AL**

## ALLUMINIO ALUMINIUM



ESTRUSO / EXTRUDED

Spessore Thickness <b>T</b>	Dimensioni Size <b>H</b>	Lunghezza Length <b>L</b>		Satinato Anodized <b>AAA</b>	Brillante Bright <b>ABA</b>	Spazzolato* Brushed <b>ASA</b>	Q.tà conf. Pcs. box
mm	mm	m	Cod. Art./Item Code	€/pz	€/pz	€/pz	pz/pcs

1	6	2,7	SPRO00061AAA27	11,95 €			10
			SPRO00061ABA27		18,47 €		
			SPRO00061ASA27			25,79 €	
	8		SPRO00081AAA27	12,84 €			
			SPRO00081ABA27		19,65 €		
			SPRO00081ASA27			27,80 €	
	10		SPRO00101AAA27	13,70 €			
			SPRO00101ABA27		20,82 €		
			SPRO00101ASA27			29,09 €	
	12,5		SPRO00121AAA27	14,91 €			
			SPRO00121ABA27		22,41 €		
			SPRO00121ASA27			31,31 €	

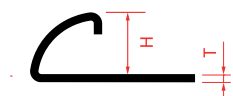

PROFILATO / PROFILED

0,7	8	2,7	SPRO00087AAA27	10,66 €			10
			SPRO00087ABA27		14,74 €		
	10		SPRO00107AAA27	11,76 €			
			SPRO00107ABA27		16,39 €		
	12,5		SPRO00127AAA27	12,52 €			
			SPRO00127ABA27		17,57 €		

**ALLUMINIO  
ANODIZZATO ARGENTO**  
 Silver Anodized Aluminium

**SPECIAL CAPSR-AL**

## ALLUMINIO ALUMINIUM



Dimensioni Size <b>H</b>		Satinato Anodized <b>AAA</b>	Brillante Bright <b>ABA</b>	Q.tà conf. Pcs. box
mm	Cod. Art./Item Code	€/pz	€/pz	

8	SPCR0008AAA0A	7,50 €		10
	SPCR0008ABA0A		7,50 €	
10	SPCR0010AAA0A	7,50 €		
	SPCR0010ABA0A		7,50 €	
12	SPCR0012AAA0A	7,50 €		
	SPCR0012ABA0A		7,50 €	

\* Note: Prodotto con disponibilità limitata. Verificare prima dell'ordine.

\* Note: Product with limited availability. Check before ordering.

A = Tappo semplice / Simple cap

O-RING fornito per profilo spessore 0,7 mm / O-RING to use with profiles thickness 0,7 mm

**ALLUMINIO  
ANODIZZATO NERO\***  
 Black Anodized Aluminium

	Spessore Thickness <b>T</b>	Dimensioni Size <b>H</b>	Lunghezza Length		Satinato Anodized <b>AAN</b>	Brillante Bright <b>ABN</b>	Spazzolato* Brushed <b>ASN</b>	Q.tà conf. Pcs. box
<b>SPECIAL ROUND AL*</b>	mm	mm	m	Cod. Art./Item Code	€/pz	€/pz	€/pz	pz/pcs

**ALLUMINIO ALUMINIUM**

ESTRUSO / EXTRUDED

1	6**	2,7	SPRO00061AAN27	14,48 €			10
			SPRO00061ABN27		24,36 €		
			SPRO00061ASN27			32,51 €	
	8		SPRO00081AAN27	16,64 €			
			SPRO00081ABN27		25,91 €		
			SPRO00081ASN27			34,48 €	
	10		SPRO00101AAN27	17,75 €			
			SPRO00101ABN27		27,46 €		
			SPRO00101ASN27			36,66 €	
	12,5		SPRO00121AAN27	19,31 €			
			SPRO00121ABN27		29,56 €		
			SPRO00121ASN27			39,46 €	

**ALLUMINIO  
ANODIZZATO ORO\***  
 Gold Anodized Aluminium

	Spessore Thickness <b>T</b>	Dimensioni Size <b>H</b>	Lunghezza Length		Satinato Anodized <b>AAO</b>	Brillante Bright <b>ABO</b>	Q.tà conf. Pcs. box
<b>SPECIAL ROUND AL*</b>	mm	mm	m	Cod. Art./Item Code	€/pz	€/pz	pz/pcs

**ALLUMINIO ALUMINIUM**

ESTRUSO / EXTRUDED

1	6**	2,7	SPRO00061AAO27	13,76 €			10
			SPRO00061ABO27		21,65 €		
	8		SPRO00081AAO27	14,78 €			
			SPRO00081ABO27		23,03 €		
	10		SPRO00101AAO27	15,77 €			
			SPRO00101ABO27		24,40 €		
	12,5		SPRO00121AAO27	17,16 €			
			SPRO00121ABO27		26,26 €		

\* Note: Prodotto con disponibilità limitata. Verificare prima dell'ordine.

\* Note: Product with limited availability. Check before ordering.

\*\* Articolo a richiesta. Ordine minimo 100 pz

\*\* Article on request. Minimum order 100 pcs



	Spessore Thickness <b>T</b>	Dimensioni Size <b>H</b>	Lunghezza Length		Acciaio Lucido Polished S-Steel	Acciaio Spazzolato Brushed S-Steel	Q.tà conf. Pcs. box
<b>SPECIAL ROUND AC</b>	mm	mm	m	Cod. Art./Item Code	€/pz	€/pz	pz/pcs

ACCIAIO S-STEEL  
AISI 304

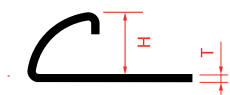

0,7	8	2,7	SPRO00087IL27	21,68 €		10
			SPRO00087IS27		28,03 €	
	10		SPRO00107IL27	24,50 €		
			SPRO00107IS27		30,86 €	
	12,5		SPRO00127IL27	26,55 €		
			SPRO00127IS27		32,90 €	
	15		SPRO00157IL27	30,57 €		
			SPRO00157IS27		36,93 €	

**SPECIAL CAPSR-AC**

ACCIAIO S-STEEL  
AISI 304



	8		SPCR0008PVA0A	14,50 €		10
			SPCR0008PVS0A		15,50 €	
	10		SPCR0010PVA0A	14,50 €		
			SPCR0010PVS0A		15,50 €	
	12,5		SPCR0012PVA0A	14,50 €		
			SPCR0012PVS0A		15,50 €	

	Dimensioni Size <b>H</b>	Lunghezza Length		PVC bianco White PVC	Quantità Pcs. box
<b>SPECIAL ROUND-PVC</b>	mm	m	Cod. Art./Item Code	€/pz	pz/pcs

PVC PVC



6	2,60	SPRO0006PVB25	2,69 €	10
8		SPRO0008PVB25	2,98 €	
10		SPRO0010PVB25	3,71 €	
12		SPRO0012PVB25	4,12 €	

 Colori disponibili nella pagina seguente  
 Other colours available on the next page

<b>SPECIAL CAPSR-PVC</b>	Dimensioni Size <b>H</b>	Lunghezza Length		PVC colorato Colored PVC	Quantità Pcs. box
	mm	m	Cod. Art./Item Code	€/pz	pz/pcs

PVC PVC



6		SPCR0006PB00	0,86 €	10
8		SPCR0008PB00	0,86 €	
10		SPCR0010PB00	0,86 €	
12		SPCR0012PB00	0,86 €	

<b>SPECIAL ROUND-PVC</b>	Dimensioni Size <b>H</b>	Lunghezza Length		PVC colorato Colored PVC		Quantità Pcs. box
	mm	m	Cod. Art./Item Code	colore/colour	€/pz	pz/pcs

PVC PVC



10	2,60	SPRO0010PVA26	Avorio/Ivory	4,11 €	10
		SPRO0010PVR26	Rosa/Pink	4,11 €	
		SPRO0010PVG26	Grigio/Grey	4,11 €	
		SPRO0010PVC26	Celeste/Light blue	4,11 €	





SPECIAL ROUND-PVC	Dimensioni Size <b>H</b>	Lunghezza Length		PVC marmorizzato marbled PVC		Quantità Packing
	mm	m	Cod. Art./Item Code	colore/colour	€/pz	pz/pcs

PVC PVC



10	2,6	SPRO0010PVMO26	Rosa/Pink	5,60 €	60
		SPRO0010PVMP26	Rosa pesca/Peach pink	5,60 €	
		SPRO0010PVMB26	Beige chiaro/Light beige	5,60 €	
		SPRO0010PVMS26	Beige sabbia/Sand beige	5,60 €	
		SPRO0010PVMT26	Beige tabacco/Tobacco beige	5,60 €	
		SPRO0010PVMV26	Travertino grigio/Travertine grey	5,60 €	
		SPRO0010PVME26	Crema/Yellow cream	5,60 €	
		SPRO0010PVMN26	Travertino beige/Travertine beige	5,60 €	
		SPRO0010PVMD26	Verde/Green	5,60 €	
		SPRO0010PVMZ26	Verde brazil/Brazil green	5,60 €	
		SPRO0010PVM I26	Grigio/ Grey	5,60 €	



**ALLUMINIO**  
**ANODIZZATO ARGENTO**  
 Silver Anodized Aluminium

	Spessore <i>Thickness</i> <b>T</b>	Dimensioni <i>Size</i> <b>H</b>	Lunghezza <i>Length</i>		Satinato <i>Anodized</i> <b>AAA</b>	Brillante <i>Bright</i> <b>ABA</b>	Spazzolato* <i>Brushed</i> <b>ASA</b>	Q.tà conf. <i>Pcs. box</i>
<b>SPECIAL SQUARE AL</b>	mm	mm	m	Cod. Art./Item Code	€/pz	€/pz	€/pz	pz/pcs

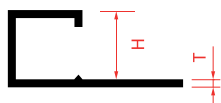
**ALLUMINIO ALUMINIUM**

ESTRUSO / EXTRUDED

1	4,5	2,7	SPSQ00451AAA27	11,95 €			
			SPSQ00451ABA27		18,47 €		
			SPSQ00451ASA27			25,81 €	
	6		SPSQ00061AAA27	12,78 €			
			SPSQ00061ABA27		19,57 €		
			SPSQ00061ASA27			27,38 €	
	8		SPSQ00081AAA27	13,13 €			
			SPSQ00081ABA27		20,02 €		
			SPSQ00081ASA27			28,99 €	
	10		SPSQ00101AAA27	14,31 €			
			SPSQ00101ABA27		21,61 €		
			SPSQ00101ASA27			30,20 €	
12,5	SPSQ00121AAA27	16,08 €					
	SPSQ00121ABA27		23,97 €				
	SPSQ00121ASA27			33,50 €			

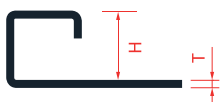

PROFILATO / PROFILED

mm	mm	m	Cod. Art./Item Code	€/pz	€/pz	pz/pcs
0,7	8	2,7	SPSQ00087AAA27	10,55 €		10
			SPSQ00087ABA27		14,58 €	
	10		SPSQ00107AAA27	11,95 €		
			SPSQ00107ABA27		16,71 €	
	12,5		SPSQ00127AAA27	13,13 €		
			SPSQ00127ABA27		18,49 €	

**ALLUMINIO**  
**ANODIZZATO ARGENTO**  
 Silver Anodized Aluminium

	Dimensioni <i>Size</i> <b>H</b>		Satinato <i>Anodized</i> <b>AAA</b>	Brillante <i>Bright</i> <b>ABA</b>	Q.tà conf. <i>Pcs. box</i>
<b>SPECIAL CAPSQ-AL</b>	mm	Cod. Art./Item Code	€/pz	€/pz	

**ALLUMINIO ALUMINIUM**

8	SPCQ0008AAA0A	7,50 €			10
	SPCQ0008ABA0A		7,50 €		
10	SPCQ0010AAA0A	7,50 €			
	SPCQ0010ABA0A		7,50 €		
12	SPCQ0012AAA0A	7,50 €			
	SPCQ0012ABA0A		7,50 €		

A = Tappo semplice / Simple cap

O-RING fornito per profilo spessore 0,7 mm / O-RING to use with profiles thickness 0,7 mm

\* Note: Prodotto con disponibilità limitata. Verificare prima dell'ordine.

\* Note: Product with limited availability. Check before ordering.

**ALLUMINIO**  
**ANODIZZATO NERO\***  
 Black Anodized Aluminium

	Spessore Thickness <b>T</b>	Dimensioni Size <b>H</b>	Lunghezza Length		Satinato Anodized <b>AAN</b>	Brillante Bright <b>ABN</b>	Spazzolato* Brushed <b>ASN</b>	Q.tà conf. Pcs. box
<b>SPECIAL SQUARE AL*</b>	mm	mm	m	Cod. Art./Item Code	€/pz	€/pz	€/pz	pz/pcs

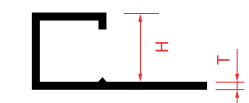
**ALLUMINIO ALUMINIUM**

ESTRUSO / EXTRUDED

1	4,5**	2,7	SPSQ00451AAN27	15,48 €				10
			SPSQ00451ABN27		24,36 €			
			SPSQ00451ASN27			32,51 €		
	6**		SPSQ00061AAN27	16,54 €				
			SPSQ00061ABN27		25,82 €			
			SPSQ00061ASN27			34,45 €		
	8		SPSQ00081AAN27	17,01 €				
			SPSQ00081ABN27		24,40 €			
			SPSQ00081ASN27			35,25 €		
	10		SPSQ00101AAN27	18,52 €				
			SPSQ00101ABN27		28,49 €			
			SPSQ00101ASN27			38,04 €		
12,5	SPSQ00121AAN27	20,82 €						
	SPSQ00121ABN27		31,60 €					
	SPSQ00121ASN27			42,19 €				

**ALLUMINIO**  
**ANODIZZATO ORO\***  
 Gold Anodized Aluminium

	Spessore Thickness <b>T</b>	Dimensioni Size <b>H</b>	Lunghezza Length		Satinato Anodized <b>AAO</b>	Brillante Bright <b>ABO</b>	Q.tà conf. Pcs. box
<b>SPECIAL SQUARE AL*</b>	mm	mm	m	Cod. Art./Item Code	€/pz	€/pz	pz/pcs

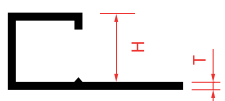
**ALLUMINIO ALUMINIUM**

ESTRUSO / EXTRUDED

1	4,5**	2,7	SPSQ00451AAO27	13,76 €			10
			SPSQ00451ABO27		21,65 €		
	6**		SPSQ00061AAO27	14,71 €			
			SPSQ00061ABO27		22,95 €		
	8**		SPSQ00081AAO27	15,11 €			
			SPSQ00081ABO27		23,48 €		
	10		SPSQ00101AAO27	16,47 €			
			SPSQ00101ABO27		25,33 €		
	12,5		SPSQ00121AAO27	18,51 €			
			SPSQ00121ABO27		28,09 €		

\* Note: Prodotto con disponibilità limitata. Verificare prima dell'ordine.

\* Note: Product with limited availability. Check before ordering.

\*\* Articolo a richiesta. Ordine minimo 100 pz

\*\* Article on request. Minimum order 100 pcs

**ALLUMINIO VERNICIATO**  
**EFFETTO PIETRA\***  
Stone effect painted  
aluminum

	Spessore Thickness <b>T</b>	Dim. Size <b>H</b>	Lungh. Length		Anthracite Stone <b>AGP</b>	White Stone <b>ABS</b>	Beige Stone <b>ABP</b>	Black Stone <b>ANS</b>	Brown Stone <b>AMS</b>	Q.tà conf. Pcs. box
<b>SPECIAL SQUARE AL</b>	mm	mm	m	Cod. Art./Item Code	€/pz	€/pz	€/pz	€/pz	€/pz	pz/pcs

ALLUMINIO ALUMINIUM

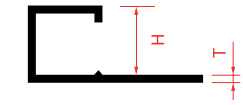
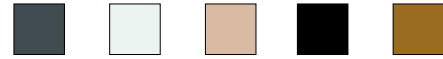

ESTRUSO / EXTRUDED

1	10	2,7	SPSQ00101AGP27	28,10 €						10	
			SPSQ00101ABS27		28,10 €						
			SPSQ00101ABP27			28,10 €					
			SPSQ00101ANS27				28,10 €				
			SPSQ00101AMS27					28,10 €			
	12,5		SPSQ00121AGP27	29,70 €							
			SPSQ00121ABS27		29,70 €						
			SPSQ00121ABP27			29,70 €					
			SPSQ00121ANS27				29,70 €				
			SPSQ00121AMS27						29,70 €		

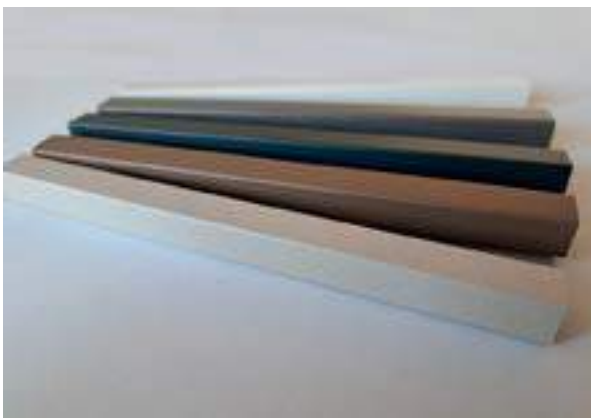

\* Note: Prodotto con disponibilità limitata. Verificare prima dell'ordine.  
\* Note: Product with limited availability. Check before ordering.



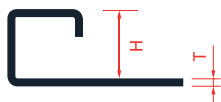

SPECIAL SQUARE AC	Spessore Thickness <b>T</b>	Dimensioni Size <b>H</b>	Lunghezza Length <b>L</b>	Cod. Art./Item Code	Acciaio Lucido Polished S-Steel	Acciaio Spazzolato Brushed S-Steel	Q.tà conf. Pcs. box
	mm	mm	m		€/pz	€/pz	pz/pcs

 ACCIAIO S-STEEL  
 AISI 304

0,7	8	2,7	SPSQ00087IL27	21,42 €		10
			SPSQ00087IS27		27,78 €	
	10		SPSQ00107IL27	25,07 €		
			SPSQ00107IS27		31,43 €	
	11		SPSQ00117IL27	26,78 €		
			SPSQ00117IS27		32,58 €	
	12,5		SPSQ00127IL27	28,10 €		
			SPSQ00127IS27		34,44 €	

Dimensioni Size <b>H</b>	Cod. Art./Item Code	Acciaio Lucido Polished S-Steel	Acciaio Spazzolato Brushed S-Steel	Q.tà conf. Pcs. box
mm		€/pz	€/pz	

**SPECIAL CAPSQ-AC**

 ACCIAIO S-STEEL  
 AISI 304

8	SPCQ0008ILOA	14,50 €		10
	SPCQ0008ISOA		15,50 €	
10	SPCQ0010ILOA	14,50 €		
	SPCQ0010ISOA		15,50 €	
12	SPCQ0012ILOA	14,50 €		
	SPCQ0012ISOA		15,50 €	

SPECIAL SQUARE AC ROVESCiato	Spessore Thickness <b>T</b>	Dimensioni Size <b>H - L</b>	Lunghezza Length <b>L</b>	Cod. Art./Item Code	Lucido* Polished	Spazzolato* Brushed	Q.tà conf. Pcs. box
	mm	mm	m		€/pz	€/pz	pz/pcs

 ACCIAIO S-STEEL  
 AISI 304

0,7	9	2,7	SPSQ0097IL27R	33,35 €		10
			SPSQ0097IS27R		39,29 €	
	11		SPSQ0117IL27R	36,72 €		
			SPSQ0117IS27R		42,26 €	
	12		SPSQ0127IL27R	38,70 €		
			SPSQ0127IS27R		44,64 €	

\* Note: Prodotto con disponibilità limitata. Verificare prima dell'ordine.

\* Note: Product with limited availability. Check before ordering.

A = Tappo semplice / Simple cap

O-RING fornito per profilo spessore 0,7 mm / O-RING to use with profiles thickness 0,7 mm

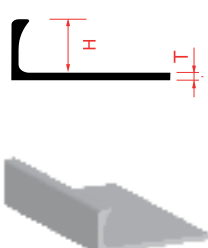

**ALLUMINIO ANODIZZATO  
ARGENTO\***  
 Argento Anodized Aluminium

	Spessore Thickness <b>T</b>	Dimensioni Size <b>H</b>	Lunghezza Length		Satinato Anodized <b>AAA</b>	Brillante Bright <b>ABA</b>	Spazzolato* Brushed <b>ASA</b>	Q.tà conf. Pcs. box
<b>SPECIAL TERM-AL</b>	mm	mm	m	Cod. Art./Item Code	€/pz	€/pz	€/pz	pz/pcs
<b>ALLUMINIO ALUMINIUM</b>								
	1	4,5	2,7	SPTE0045AAA27	10,30 €			10
				SPTE0045ABA27		16,24 €		
				SPTE0045ASA27			22,69 €	
		SPTE0006AAA27		10,58 €				
		SPTE0006ABA27			16,66 €			
		SPTE0006ASA27				23,26 €		
		SPTE0008AAA27		10,99 €				
		SPTE0008ABA27			17,19 €			
		SPTE0008ASA27				24,02 €		
		SPTE0010AAA27		11,41 €				
		SPTE0010ABA27			17,74 €			
		SPTE0010ASA27				24,78 €		
		SPTE0011AAA27		11,86 €				
		SPTE0011ABA27			18,26 €			
		SPTE0011ASA27				25,22 €		
		SPTE0012AAA27		11,95 €				
		SPTE0012ABA27			18,47 €			
		SPTE0012ASA27				25,81 €		
SPTE0015AAA27	12,39 €							
SPTE0015ABA27		19,10 €						
SPTE0015ASA27			26,69 €					

**ALLUMINIO  
ANODIZZATO NERO\***  
 Black Anodized Aluminium

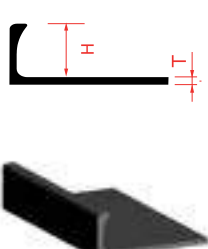
					<b>AAN</b>	<b>ABN</b>	<b>ASN*</b>	
<b>SPECIAL TERM-AL</b>	mm	mm	m	Cod. Art./Item Code	€/pz	€/pz	€/pz	pz/pcs
<b>ALLUMINIO ALUMINIUM</b>								
	1	4,5**	2,7	SPTE0045AAN27	13,34 €			10
				SPTE0045ABN27		21,43 €		
				SPTE0045ASN27			28,59 €	
		SPTE0006AAN27		13,71 €				
		SPTE0006ABN27			21,96 €			
		SPTE0006ASN27				29,33 €		
		SPTE0008AAN27		14,25 €				
		SPTE0008ABN27			22,68 €			
		SPTE0008ASN27				30,27 €		
		SPTE0010AAN27		14,77 €				
		SPTE0010ABN27			23,40 €			
		SPTE0010ASN27				31,25 €		
		SPTE0012AAN27		15,48 €				
		SPTE0012ABN27			24,36 €			
		SPTE0012ASN27				32,51 €		
SPTE0015AAN27	16,06 €							
SPTE0015ABN27		25,20 €						
SPTE0015ASN27			33,63 €					

\*\* Articolo a richiesta. Ordine minimo 100 pz - \*\* Article on request. Minimum order 100 pcs

**ALLUMINIO**  
**ANODIZZATO ORO\***  
 Gold Anodized Aluminium

**SPECIAL TERM-AL**

Spessore Thickness <b>T</b>	Dimensioni Size <b>H</b>	Lunghezza Length <b>L</b>		Satinato Anodized <b>AAO</b>	Brillante Bright <b>ABO</b>	Q.tà conf. Pcs. box
mm	mm	m	Cod. Art./Item Code	€/pz	€/pz	pz/pcs

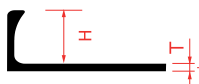
**ALLUMINIO ALUMINIUM**

1	4,5**	2,7	SPTE0045AAO27	11,86 €		10
			SPTE0045ABO27		19,05 €	
	6**		SPTE0006AAO27	12,19 €		
			SPTE0006ABO27		19,53 €	
	8		SPTE0008AAO27	12,66 €		
			SPTE0008ABO27		20,16 €	
	10		SPTE0010AAO27	13,37 €		
			SPTE0010ABO27		20,80 €	
	12,5		SPTE0012AAO27	13,76 €		
			SPTE0012ABO27		21,65 €	
	15**		SPTE0015AAO27	14,27 €		
			SPTE0015ABO27		22,40 €	

**ALLUMINIO VERNICIATO**  
**EFFETTO PIETRA**  
 Stone effect painted  
 aluminum

**SPECIAL TERM-AL**

Spessore Thickness <b>T</b>	Dim. Size <b>H</b>	Lungh. Length <b>L</b>		Anthracite Stone <b>AGP</b>	White Stone <b>ABS</b>	Beige Stone <b>ABP</b>	Black Stone <b>ANS</b>	Brown Stone <b>AMS</b>	Q.tà conf. Pcs. box
mm	mm	m	Cod. Art./Item Code	€/pz	€/pz	€/pz	€/pz	€/pz	pz/pcs

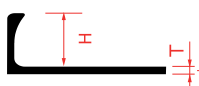
**ALLUMINIO ALUMINIUM**

1	10	2,7	SPTE0010AGP27	22,36 €					10
			SPTE0010ABS27		22,36 €				
			SPTE0010ABP27			22,36 €			
			SPTE0010ANS27				22,36 €		
			SPTE0010AMS27					22,36 €	
	11		SPTE0011AGP27	23,48 €					
			SPTE0011ABS27		23,48 €				
			SPTE0011ABP27			23,48 €			
			SPTE0011ANS27				23,48 €		
			SPTE0011AMS27					23,48 €	
	12,5		SPTE0012AGP27	24,69 €					
			SPTE0012ABS27		24,69 €				
SPTE0012ABP27				24,69 €					
SPTE0012ANS27					24,69 €				
		SPTE0012AMS27					24,69 €		

\* Note: Prodotto con disponibilità limitata. Verificare prima dell'ordine.

\* Note: Product with limited availability. Check before ordering.

\*\* Articolo a richiesta. Ordine minimo 100 pz - \*\* Article on request. Minimum order 100 pcs

	Spessore Thickness <b>T</b>	Dimensioni Size <b>H</b>	Lunghezza Length		Acciaio Lucido Polished S-Steel	Acciaio Spazzolato Brushed S-Steel	Q.tà conf. Pcs. box
<b>SPECIALTERM-AC</b>	mm	mm	m	Cod. Art./Item Code	€/pz	€/pz	pz/pcs

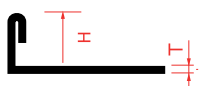
**ACCIAIO S-STEEL  
AISI 304**

0,7	8	2,7	SPTE00087IL27	20,92 €		10
			SPTE00087IS27		27,27 €	
	10		SPTE00107IL27	21,87 €		
			SPTE00107IS27		28,23 €	
	11		SPTE00117IL27	22,78 €		
			SPTE00117IS27		29,08 €	
	12,5		SPTE00127IL27	23,07 €		
			SPTE00127IS27		29,43 €	
	15		SPTE00157IL27	24,28 €		
			SPTE00157IS27		30,63 €	
	20		SPTE00207IL27	34,70 €		
			SPTE00207IS27		40,48 €	
	25		SPTE00257IL27	39,88 €		
			SPTE00257IS27		45,66 €	
	30		SPTE00307IL27	42,13 €		
			SPTE00307IS27		47,90 €	

	Spessore Thickness <b>T</b>	Dimensioni Size <b>H</b>	Lunghezza Length		Acciaio Lucido Polished S-Steel	Acciaio Spazzolato Brushed S-Steel	Q.tà conf. Pcs. box
	mm	mm	m	Cod. Art./Item Code	€/pz	€/pz	pz/pcs

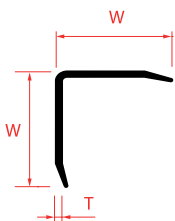
**SPECIAL CORNER AC**
**ACCIAIO S-STEEL  
AISI 304**

0,7	15	2,7	SPCO15157IL27	20,52 €		10
			SPCO1515IS27		25,23 €	
	20		SPCO20207IL27	22,97 €		
			SPCO2020IS27		29,33 €	
	25		SPCO25257IL27	27,84 €		
			SPCO2525IS27		33,62 €	
	30		SPCO30307IL27	31,91 €		
			SPCO30307IS27		38,26 €	



	Spessore <i>Thickness</i> <b>T</b>	Dimensioni <i>Size</i> <b>W</b>	Dimensioni <i>Size</i> <b>H</b>	Lunghezza <i>Length</i>		Acciaio Lucido <i>Polished S-Steel</i>	Q.tà conf. <i>Pcs. box</i>
<b>SPECIAL CORNER POSA AC</b>	mm	mm	mm	m	Cod. Art./Item Code	€/pz	pz/pcs

ACCIAIO *S-STEEL*  
AISI 304

0,7	30	8	2,7	SPCS30307IL08	64,75 €	10
		10		SPCS30307IL10	66,53 €	
		12		SPCS30307IL12	68,18 €	

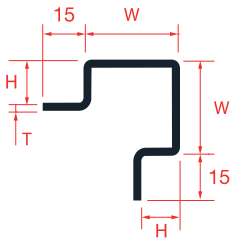

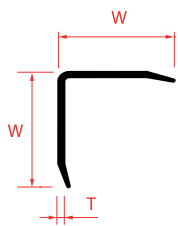
**ALLUMINIO  
ANODIZZATO ARGENTO**  
 Silver Anodized Aluminium

Spessore Thickness <b>T</b>	Dimensioni Size <b>W</b>	Lunghezza Length		Satinato Anodized	Brillante Bright	Spazzolato* Brushed	Q.tà conf. Pcs. box
-----------------------------------	--------------------------------	---------------------	--	----------------------	---------------------	------------------------	------------------------

SPECIAL CORNER AL	mm	mm	m	Cod. Art./Item Code	€/pz	€/pz	€/pz	pz/pcs
-------------------	----	----	---	---------------------	------	------	------	--------



1	25	3	SPCO25251AAA27	12,04 €			10
			SPCO25251ABA27		18,85 €		
			SPCO25251ASA27			27,49 €	

**ALLUMINIO  
ANODIZZATO NERO\***  
 Black Anodized Aluminium

SPECIAL CORNER AL	mm	mm	m	Cod. Art./Item Code	€/pz	€/pz	€/pz	pz/pcs
-------------------	----	----	---	---------------------	------	------	------	--------



1	25	3	SPCO25251AAN27	17,02 €			10
			SPCO25251ABN27		27,10 €		
			SPCO25251ASN27			36,08 €	

**ALLUMINIO  
ANODIZZATO ORO\***  
 Gold Anodized Aluminium

SPECIAL CORNER AL	mm	mm	m	Cod. Art./Item Code	€/pz	€/pz	pz/pcs
-------------------	----	----	---	---------------------	------	------	--------



1	25	3	SPCO25251AAO27	15,13 €		10
			SPCO25251ABO27		24,07 €	

\*\* Articolo a richiesta con quantità e tempi da definire, disponibili anche nei seguenti colori:

\*\* Item on on request with quantities and times to be defined before ordering. Available in the following colours:



**AGP**  
Anthracite  
Stone



**ABS**  
White  
Stone



**ABP**  
Beige  
Stone



**ANS**  
Black  
Stone



**AMS**  
Brown  
Stone

\* Note: Prodotto con disponibilità limitata. Verificare prima dell'ordine.

\* Note: Product with limited availability. Check before ordering.



	Spessore Thickness <b>T</b>	Dimensioni Size <b>W</b>	Lunghezza Length		PVC bianco White PVC	PVC marrone Brown PVC	Q.tà conf. Pcs. box
<b>SPECIAL CORNER PVC</b>	mm	mm	m	Cod. Art./Item Code	€/pz	€/pz	pz/pcs

PVC PVC

1	28	3	SPCO2828PVB03	6,70 €		20
			SPCO2828PVM03		6,70 €	

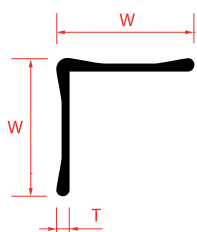

<b>SPECIAL CORNER PVC</b>	mm	mm	m	Cod. Art./Item Code	€/pz	€/pz	pz/pcs
---------------------------	----	----	---	---------------------	------	------	--------

PVC PVC

1	22	2,6	SPCO2222PVB26	3,65 €		110
---	----	-----	---------------	--------	--	-----

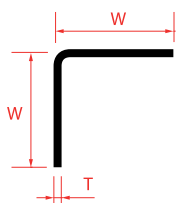



SPECIAL  
PROFILES

**Profili per Pavimenti**  
Profiles for Floors



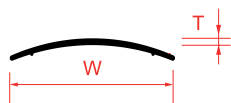

Spessore Thickness <b>T</b>	Dimensioni Size <b>W</b>	Lunghezza Length		Satinato Anodized	Brillante Bright	Spazzolato* Brushed	Q.tà conf. Pcs. box
-----------------------------------	--------------------------------	---------------------	--	----------------------	---------------------	------------------------	------------------------

SPECIAL SEMI-AL	mm	mm	m	Cod. Art./Item Code	€/pz	€/pz	€/pz	pz/pcs
-----------------	----	----	---	---------------------	------	------	------	--------

**ALLUMINIO  
ANODIZZATO ARGENTO\***  
 Silver Anodized  
 Aluminium

1	30	2,7	SPSE00301AAA27	9,50 €			10	
			SPSE00301ABA27		13,41 €			
			SPSE00301ASA27			17,74 €		
		<i>Con adesivo Self adhesive</i>						
		2,7	SPSE0030AAA27A	11,97 €				
			SPSE0030ABA27A		16,90 €			
			SPSE0030ASA27A			23,60 €		
		<i>Profili in blister Thermo packed profiles</i>						
		0,9	SPSE00301AAA09	3,69 €				
			SPSE00301ABA09		5,21 €			
			SPSE00301ASA09			7,29 €		
		<i>Blister con adesivo Self adhesive Thermo packed profiles</i>						
		0,9	SPSE0030AAA09A	4,65 €				
			SPSE0030ABA09A		6,57 €			
			SPSE0030ASA09A			9,12 €		

SPECIAL SEMI-AL	mm	mm	m	Cod. Art./Item Code	€/pz	€/pz	€/pz	pz/pcs
-----------------	----	----	---	---------------------	------	------	------	--------

**ALLUMINIO ANODIZZATO  
NERO\***  
 Black Anodized  
 Aluminium

1	30	2,7	SPSE00301AAN27	12,86 €			10	
			SPSE00301ABN27		18,16 €			
			SPSE00301ASN27			23,61 €		
		<i>Con adesivo Self adhesive</i>						
		2,7	SPSE0030AAN27A	16,20 €				
			SPSE0030ABN27A		22,89 €			
			SPSE0030ASN27A			29,75 €		
		<i>Profili in blister Thermo packed profiles</i>						
		0,9	SPSE0030AAN09A	5,22 €				
			SPSE0030ABN09A		7,37 €			
			SPSE0030ASN09A			9,58 €		
		<i>Blister con adesivo Self adhesive Thermo packed profiles</i>						
		0,9	SPSE0030AAN09A	6,58 €				
			SPSE0030ABN09A		9,29 €			
			SPSE0030ASN09A			12,07 €		

\* Note: Prodotto con disponibilità limitata. Verificare prima dell'ordine.

\* Note: Product with limited availability. Check before ordering.

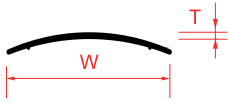

Spessore <i>Thickness</i> <b>T</b>	Dimensioni <i>Size</i> <b>W</b>	Lunghezza <i>Length</i>		Satinato <i>Anodized</i>	Brillante <i>Bright</i>	Q.tà conf. <i>Pcs. box</i>
--	---------------------------------------	----------------------------	--	-----------------------------	----------------------------	-------------------------------

SPECIAL SEMI-AL	mm	mm	m	Cod. Art./Item Code	€/pz	€/pz	pz/pcs
-----------------	----	----	---	---------------------	------	------	--------

**ALLUMINIO ANODIZZATO  
ORO**  
 Gold Anodized Aluminium

1	30	2,7	SPSE00301AAO27	10,93 €		10	
			SPSE00301ABO27		15,71 €		
		<i>Con adesivo Self adhesive</i>					
		2,7	SPSE0030AAO27A	13,78 €			
			SPSE0030ABO27A*		19,79 €		
		<i>Profili in blister Thermo packed profiles</i>					
		0,9	SPSE00301AAO09	4,44 €			
			SPSE00301ABO09		6,28 €		
		<i>Blister con adesivo Self adhesive Thermo packed profiles</i>					
		0,9	SPSE0030AAO09A	5,60 €			
SPSE0030ABO09A			7,91 €				

\* Note: Prodotto con disponibilità limitata. Verificare prima dell'ordine.

\* Note: Product with limited availability. Check before ordering.

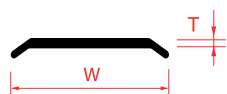

Spessore Thickness <b>T</b>	Dimensioni Size <b>W</b>	Lunghezza Length		Satinato Anodized	Brillante Bright	Spazzolato* Brushed	Q.tà conf. Pcs. box
-----------------------------------	--------------------------------	---------------------	--	----------------------	---------------------	------------------------	------------------------

SPECIAL SEMIFLAT-AL	mm	mm	m	Cod. Art./Item Code	€/pz	€/pz	€/pz	pz/pcs
---------------------	----	----	---	---------------------	------	------	------	--------

**ALLUMINIO  
ANODIZZATO ARGENTO\***  
Silver Anodized  
Aluminium



1	25	2,7	SPSF00251AAA27	10,02 €			10	
			SPSF00251ABA27		14,01 €			
			SPSF00251ASA27			20,51 €		
		<i>Con adesivo Self adhesive</i>						
		2,7	SPSF0025AAA27A	13,45 €				
			SPSF0025ABA27A		19,41 €			
			SPSF0025ASA27A			28,43 €		
		<i>Profili in blister Thermo packed profiles</i>						
		0,9	SPSF00251AAA09	3,89 €				
			SPSF00251ABA09		5,46 €			
			SPSF00251ASA09			7,94 €		
		<i>Blister con adesivo Self adhesive Thermo packed profiles</i>						
		0,9	SPSF0025AAA09A	4,91 €				
			SPSF0025ABA09A		6,86 €			
			SPSF0025ASA09A			12,12 €		

SPECIAL SEMIFLAT-AL	mm	mm	m	Cod. Art./Item Code	€/pz	€/pz	€/pz	pz/pcs
---------------------	----	----	---	---------------------	------	------	------	--------

**ALLUMINIO ANODIZZATO  
NERO\***  
Black Anodized  
Aluminium



1	25	2,7	SPSF00251AAN27	13,56 €			10	
			SPSF00251ABN27		19,31 €			
			SPSF00251ASN27			24,66 €		
		<i>Con adesivo Self adhesive</i>						
		2,7	SPSF0025AAN27A	17,09 €				
			SPSF0025ABN27A		23,90 €			
			SPSF0025ASN27A			31,07 €		
		<i>Profili in blister Thermo packed profiles</i>						
		0,9	SPSF00251AAN09	5,51 €				
			SPSF00251ABN09		7,69 €			
			SPSF00251ASN09			10,01 €		
		<i>Blister con adesivo Self adhesive Thermo packed profiles</i>						
		0,9	SPSF0025AAN09A	6,94 €				
			SPSF0025ABN09A		9,70 €			
			SPSF0025ASN09A			12,61 €		

\* Note: Prodotto con disponibilità limitata. Verificare prima dell'ordine.

\* Note: Product with limited availability. Check before ordering.

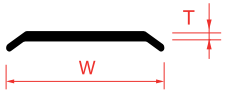

Spessore Thickness <b>T</b>	Dimensioni Size <b>W</b>	Lunghezza Length		Satinato Anodized	Brillante Bright	Q.tà conf. Pcs. box
-----------------------------------	--------------------------------	---------------------	--	----------------------	---------------------	------------------------

**SPECIAL SEMIFLAT-AL**

mm	mm	m	Cod. Art./Item Code	€/pz	€/pz	pz/pcs
----	----	---	---------------------	------	------	--------

**ALLUMINIO  
ANODIZZATO ORO\***  
 Gold Anodized Aluminium

1	25	2,7	SPSF00251AAO27	11,53 €		10		
			SPSF00251ABO27		16,42 €			
		Con adesivo <i>Self adhesive</i>						
		2,7	SPSF0025AAO27A	14,53 €				
			SPSF0025ABO27A		20,69 €			
		Profili in blister <i>Thermo packed profiles</i>						
		0,9	SPSF00251AAO09	4,69 €				
			SPSF00251ABO09		6,56 €			
		Blister con adesivo <i>Self adhesive Thermo packed profiles</i>						
		0,9	SPSF0025AAO09A	5,91 €				
			SPSF0025ABO09A		8,26 €			

Spessore Thickness <b>T</b>	Dimensioni Size <b>W - H</b>	Lunghezza Length		Lucido Polished	Spazzolato* Brushed	Q.tà conf. Pcs. box
-----------------------------------	------------------------------------	---------------------	--	--------------------	------------------------	------------------------

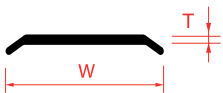
**SPECIAL SEMI FLAT-AC**
**ACCIAIO S-STEEL  
AISI 304**

0,7	25	2,7	SPSF002571L27	15,22 €		10		
			SPSF002571S27		20,99 €			
		Con adesivo <i>Self adhesive</i>						
		2,7	SPSF00251L27A	19,17 €				
			SPSF00251S27A		26,46 €			
		Profili in blister <i>Thermo packed profiles</i>						
		0,9	SPSF002571L09	5,92 €				
			SPSF002571S09		8,16 €			
		Blister con adesivo <i>Self adhesive Thermo packed profiles</i>						
		0,9	SPSF00251L09A	7,46 €				
			SPSF00251S09A		10,28 €			

\* Note: Prodotto con disponibilità limitata. Verificare prima dell'ordine.

\* Note: Product with limited availability. Check before ordering.

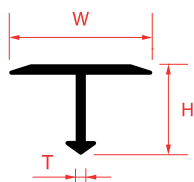

Spessore Thickness <b>T</b>	Dimensioni Size <b>W</b>	Lunghezza Length		Satinato Anodized	Brillante Bright	Spazzolato* Brushed	Q.tà conf. Pcs. box
-----------------------------------	--------------------------------	---------------------	--	----------------------	---------------------	------------------------	------------------------

SPECIALTI-AL	mm	mm	m	Cod. Art./Item Code	€/pz	€/pz	€/pz	pz/pcs
--------------	----	----	---	---------------------	------	------	------	--------

**ALLUMINIO  
ANODIZZATO ARGENTO\***  
Silver Anodized  
Aluminium



1	14x9	2,7	SPTI1409AAA27	9,08 €			10	
			SPTI1409ABA27		11,41 €			
			SPTI1409ASA27			15,88 €		
			SPTI2009AAA27	10,55 €				
			SPTI2009ABA27		12,88 €			
			SPTI2009ASA27			17,94 €		
	Profili in blister <i>Thermo packed profiles</i>							
	20x9	0,9	SPTI1409AAA09	3,63 €				
			SPTI1409ABA09		4,55 €			
			SPTI1409ASA09			6,18 €		
			SPTI2009AAA09	4,21 €				
			SPTI2009ABA09		5,15 €			
SPTI2009ASA09					7,27 €			

SPECIALTI-AL

**ALLUMINIO ANODIZZATO  
NERO\***  
Black Anodized  
Aluminium



1	14x9	2,7	SPTI1409AAN27	12,25 €			10	
			SPTI1409ABN27		15,40 €			
			SPTI1409ASN27			20,03 €		
			SPTI2009AAN27	14,23 €				
			SPTI2009ABN27		17,38 €			
			SPTI2009ASN27			22,61 €		
	Profili in blister <i>Thermo packed profiles</i>							
	20x9	0,9	SPTI1409AAN09	4,96 €				
			SPTI1409ABN09		6,24 €			
			SPTI1409ASN09			7,70 €		
			SPTI2009AAN09	5,78 €				
			SPTI2009ABN09		7,04 €			
SPTI2009ASN09					9,16 €			

\* Note: Prodotto con disponibilità limitata. Verificare prima dell'ordine.

\* Note: Product with limited availability. Check before ordering.

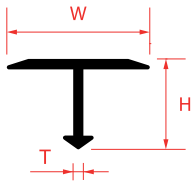

Spessore Thickness <b>T</b>	Dimensioni Size <b>W</b>	Lunghezza Length		Satinato Anodized <b>AAO</b>	Brillante Bright <b>ABO</b>	Q.tà conf. Pcs. box
-----------------------------------	--------------------------------	---------------------	--	------------------------------------	-----------------------------------	------------------------

SPECIAL TI-AL	mm	mm	m	Cod. Art./Item Code	€/pz	€/pz	pz/pcs
---------------	----	----	---	---------------------	------	------	--------

**ALLUMINIO  
ANODIZZATO ORO\***  
 Gold Anodized Aluminium



1	14x9	2,7	SPTI1409AAO27	10,90 €		10	
			SPTI1409ABO27		14,26 €		
	20x9		SPTI2009AAO27	12,66 €			
			SPTI2009ABO27		16,09 €		
	Profili in blister <i>Thermo packed profiles</i>						
	14x9	0,9	SPTI1409AAO09	4,41 €			
			SPTI1409ABO09		5,54 €		
			20x9	SPTI2009AAO09	5,13 €		
SPTI2009ABO09					6,26 €		

Spessore Thickness <b>T</b>	Dimensioni Size <b>W - H</b>	Lunghezza Length		Lucido Polished	Spazzolato* Brushed	Q.tà conf. Pcs. box
-----------------------------------	------------------------------------	---------------------	--	--------------------	------------------------	------------------------

SPECIAL TI-AC	mm	mm	m	Cod. Art./Item Code	€/pz	€/pz	pz/pcs
---------------	----	----	---	---------------------	------	------	--------

**ACCIAIO S-STEEL  
AISI 304**

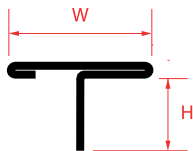
0,7	Profili in blister <i>Thermo packed profiles</i>						10
	20x8	0,9	SPTI20087ILO9	12,62 €			
			SPTI20087IS09		15,49 €		



\* Note: Prodotto con disponibilità limitata. Verificare prima dell'ordine.  
 \* Note: Product with limited availability. Check before ordering.



Spessore Thickness <b>T</b>	Dimensioni Size <b>W</b>	Lunghezza Length		Satinato Anodized	Brillante Bright	Spazzolato* Brushed	Q.tà conf. Pcs. box
-----------------------------------	--------------------------------	---------------------	--	----------------------	---------------------	------------------------	------------------------

SPECIAL TILT-AL	mm	mm	m	Cod. Art./Item Code	€/pz	€/pz	€/pz	pz/pcs
-----------------	----	----	---	---------------------	------	------	------	--------

**ALLUMINIO  
ANODIZZATO ARGENTO**  
 Silver Anodized  
 Aluminium

1	10	2,7	SPTL0010AAA27	15,42 €			10
			SPTL0010ABA27		23,10 €		
			SPTL0010ASA27			33,68 €	
Profili in blister <i>Thermo packed profiles</i>							
10	10	0,9	SPTL0010AAA09	6,16 €			10
			SPTL0010ABA09		9,23 €		
			SPTL0010ASA09			13,65 €	

**ALLUMINIO  
ANODIZZATO NERO\***  
 Black Anodized  
 Aluminium

1	10	2,7	SPTL0010AAN27	21,79 €			10
			SPTL0010ABN27		32,65 €		
			SPTL0010ASN27			42,43 €	
Profili in blister <i>Thermo packed profiles</i>							
10	10	0,9	SPTL0010AAN09	8,83 €			10
			SPTL0010ABN09		13,23 €		
			SPTL0010ASN09			17,19 €	

**ALLUMINIO  
ANODIZZATO ORO\***  
 Gold Anodized Aluminium



1	10	2,7	SPTL0010AAO27	19,37 €			10
			SPTL0010ABO27		29,03 €		
			Profili in blister <i>Thermo packed profiles</i>				
10	10	0,9	SPTL0010AAO09	7,85 €			10
			SPTL0010ABO09		11,76 €		

Spessore Thickness <b>T</b>	Dimensioni Size <b>W</b>	Lunghezza Length <b>L</b>		Naturale Natural	Satinato Silver	Q.tà conf. Pcs. box
-----------------------------------	--------------------------------	---------------------------------	--	---------------------	--------------------	------------------------

SPECIAL TILTBIG-AL	mm	mm	m	Cod. Art./Item Code	€/pz	€/pz	pz/pcs
--------------------	----	----	---	---------------------	------	------	--------

**ALLUMINIO  
ANODIZZATO ARGENTO**  
 Silver Anodized  
 Aluminium

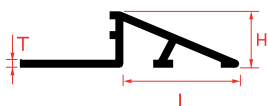
1,2	10	2,7	SPTLB0010ANA27	20,99 €		10
			SPTLB0010AAA27		30,97 €	
	12		SPTLB0012ANA27	24,34 €		
			SPTLB0012AAA27		35,43 €	



\* Note: Prodotto con disponibilità limitata. Verificare prima dell'ordine.  
 \* Note: Product with limited availability. Check before ordering.

	Spessore Thickness <b>T</b>	Dimensioni Size <b>W - H</b>	Lunghezza Length		Lucido Polished	Spazzolato* Brushed	Q.tà conf. Pcs. box
<b>SPECIAL TILT-AC</b>	mm	mm	m	Cod. Art./Item Code	€/pz	€/pz	pz/pcs

ACCIAIO S-STEEL  
AISI 304



0,7	10	2,7	SPTL001071L27	31,46 €		10
			SPTL001071S27		37,81 €	
	Profili in blister Thermo packed profiles					
	10	0,9	SPTL001071L09	12,24 €		
SPTL001071S09				14,49 €		

	Spessore Thickness <b>T</b>	Dimensioni Size <b>W - H</b>	Lunghezza Length		Lucido Polished	Spazzolato* Brushed	Q.tà conf. Pcs. box
<b>SPECIAL TILT-AC</b>	mm	mm	m	Cod. Art./Item Code	€/pz	€/pz	pz/pcs

ACCIAIO S-STEEL  
AISI 304

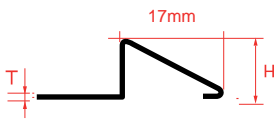

0,7	10	2,7	SPTL101871L27	40,96 €		10
			SPTL101871S27		48,50 €	



	mm	mm	m		€/pz	€/pz	pz/pcs
<b>SPECIALTERMFLAT-AC</b>				Cod. Art./Item Code			

ACCIAIO S-STEEL  
AISI 304

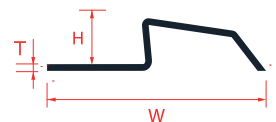

0,7	55x10	2,7	SPTF001071L27	32,23 €		10
			SPTF001071S27		38,02 €	

\* Note: Prodotto con disponibilità limitata. Verificare prima dell'ordine.  
\* Note: Product with limited availability. Check before ordering.





Spessore Thickness <b>T</b>	Dimensioni Size <b>W</b>	Lunghezza Length		Satinato Anodized <b>AAA</b>	Brillante Bright <b>ABA</b>	Q.tà conf. Pcs. box
-----------------------------------	--------------------------------	---------------------	--	------------------------------------	-----------------------------------	------------------------

SPECIAL TERMTILT-AL	mm	mm	m	Cod. Art./Item Code	€/pz	€/pz	pz/pcs
---------------------	----	----	---	---------------------	------	------	--------

**ALLUMINIO**  
**ANODIZZATO ARGENTO**  
Silver Anodized  
Aluminium



1	10	2,7	SPTT0010AAA27	14,58 €		10	
			SPTT0010ABA27		19,20 €		
			SPTT0012AAA27	17,86 €			
			SPTT0012ABA27		22,94 €		
	<i>Con adesivo Self adhesive</i>						
	10	2,7	SPTT0010AAA27A	18,37 €			
			SPTT0010ABA27A		24,19 €		
			SPTT0012AAA27A	22,50 €			
			SPTT0012ABA27A		28,91 €		
	<i>Profili in blister Blister profiles</i>						
	10	0,9	SPTT0010AAA09	6,19 €			
			SPTT0010ABA09		7,81 €		
			SPTT0012AAA09	6,93 €			
			SPTT0012ABA09		9,35 €		
	<i>Blister con adesivo Self adhesive Blister</i>						
	10	0,9	SPTT0010AAA09A	7,81 €			
SPTT0010ABA09A				9,84 €			
SPTT0012AAA09A			8,73 €				
SPTT0012ABA09A				11,77 €			



Spessore Thickness <b>T</b>	Dimensioni Size <b>W</b>	Lunghezza Length		Satinato Anodized <b>AAN</b>	Brillante Bright <b>ABN</b>	Q.tà conf. Pcs. box
-----------------------------------	--------------------------------	---------------------	--	------------------------------------	-----------------------------------	------------------------

SPECIAL TERMTILT-AL	mm	mm	m	Cod. Art./Item Code	€/pz	€/pz	pz/pcs
---------------------	----	----	---	---------------------	------	------	--------

**ALLUMINIO  
ANODIZZATO NERO\***  
Black Anodized  
Aluminium



1	10	2,7	SPTT0010AAN27	23,08 €		10		
			SPTT0010ABN27		30,39 €			
			12	2,7	SPTT0012AAN27		28,27 €	
					SPTT0012ABN27			36,31 €
	<i>Con adesivo Self adhesive</i>							
	10	2,7	SPTT0010AAN27A	29,09 €				
			SPTT0010ABN27A		38,28 €			
			12	2,7	SPTT0012AAN27A		35,62 €	
					SPTT0012ABN27A			45,75 €
	<i>Profili in blister Thermo packed profiles</i>							
	10	0,9	SPTT0010AAN09	9,22 €				
			SPTT0010ABN09		12,13 €			
			12	0,9	SPTT0012AAN09		11,27 €	
					SPTT0012ABN09			14,50 €
	<i>Blister con adesivo Self adhesive Thermo packed profiles</i>							
	10	0,9	SPTT0010AAN09A	11,62 €				
			SPTT0010ABN09A		15,28 €			
			12	0,9	SPTT0012AAN09A		14,20 €	
					SPTT0012ABN09A			18,27 €

\* Note: Prodotto con disponibilità limitata. Verificare prima dell'ordine.

\* Note: Product with limited availability. Check before ordering.



Spessore <i>Thickness</i> <b>T</b>	Dimensioni <i>Size</i> <b>W</b>	Lunghezza <i>Length</i>		Satinato <i>Anodized</i> <b>AAO</b>	Brillante <i>Bright</i> <b>ABO</b>	Q.tà conf. <i>Pcs. box</i>
--	---------------------------------------	----------------------------	--	---	--	-------------------------------

SPECIAL TERMTILT-AL	mm	mm	m	Cod. Art./Item Code	€/pz	€/pz	pz/pcs
---------------------	----	----	---	---------------------	------	------	--------

**ALLUMINIO  
ANODIZZATO ORO\***  
Gold Anodized Aluminium

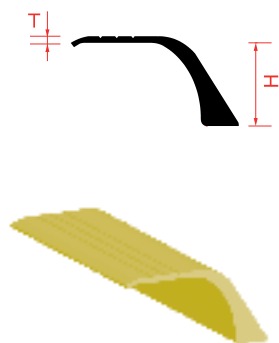

1	10	2,7	SPTT0010AAO27	17,10 €		10	
			SPTT0010ABO27		22,50 €		
			SPTT0012AAO27	20,94 €			
			SPTT0012ABO27		26,89 €		
	<i>Con adesivo Self adhesive</i>						
	10	2,7	SPTT0010AAO27A	21,54 €			
			SPTT0010ABO27A		28,35 €		
			SPTT0012AAO27A	26,38 €			
			SPTT0012ABO27A		33,89 €		
	<i>Profili in blister Thermo packed profiles</i>						
	10	0,9	SPTT0010AAO09	6,83 €			
			SPTT0010ABO09		8,98 €		
			SPTT0012AAO09	8,36 €			
			SPTT0012ABO09		10,74 €		
	<i>Blister con adesivo Self adhesive Thermo packed profiles</i>						
	10	0,9	SPTT0010AAO09A	8,60 €			
SPTT0010ABO09A				11,32 €			
SPTT0012AAO09A			10,53 €				
SPTT0012ABO09A				13,53 €			

\* Note: Prodotto con disponibilità limitata. Verificare prima dell'ordine.

\* Note: Product with limited availability. Check before ordering.

	Spessore Thickness <b>T</b>	Dimensioni Size <b>W - H</b>	Lunghezza Length		Lucido Polished	Spazzolato* Brushed	Q.tà conf. Pcs. box
<b>SPECIALTERMTILT-AC</b>	mm	mm	m	Cod. Art./Item Code	€/pz	€/pz	pz/pcs

ACCIAIO S-STEEL  
ISI 304

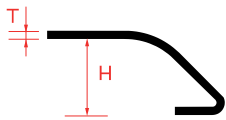

0,7	10	2,7	SPTT00107IL27	19,99 €		10		
			SPTT00107IS27		25,77 €			
			SPTT00127IL27	21,33 €				
			SPTT00127IS27		27,10 €			
	Con adesivo <i>Self adhesive</i>							
	12	2,7	SPTT00107IL27A	25,19 €				
			SPTT00107IS27A		32,47 €			
			SPTT00127IL27A	26,88 €				
			SPTT00127IS27A		34,15 €			
	Profili in blister <i>Thermo packed profiles</i>							
	10	0,9	SPTT00107IL09	7,78 €				
			SPTT00107IS09		10,02 €			
			SPTT00127IL09	8,29 €				
			SPTT00127IS09		10,54 €			
	Blister con adesivo <i>Self adhesive Thermo packed profiles</i>							
	12	0,9	SPTT00107IL09A	9,80 €				
SPTT00107IS09A				12,63 €				
SPTT00127IL09A			10,45 €					
SPTT00127IS09A				13,28 €				

	Spessore Thickness <b>T</b>	Dimensioni Size <b>H - L</b>	Lunghezza Length		Lucido Polished	Spazzolato* Brushed	Q.tà conf. Pcs. box
<b>SPECIAL SQUARE AC ROVESCiato</b>	mm	mm	m	Cod. Art./Item Code	€/pz	€/pz	pz/pcs

ACCIAIO S-STEEL  
AISI 304



0,7	9	2,7	SPSQ00097IL27R	33,35 €		10
			SPSQ00097IS27R		39,29 €	
	11		SPSQ00097IL27R	36,32 €		
			SPSQ00097IS27R		42,26 €	
	12		SPSQ00097IL27R	38,70 €		
			SPSQ00097IS27R		44,64 €	



\* Note: Prodotto con disponibilità limitata. Verificare prima dell'ordine.  
\* Note: Product with limited availability. Check before ordering.



Spessore Thickness <b>T</b>	Dimensioni Size <b>W</b>	Lunghezza Length		Naturale Natural <b>ANA</b>	Satinato Anodized <b>AAA</b>	Brillante* Bright <b>ABA</b>	Q.tà conf. Pcs. box
-----------------------------------	--------------------------------	---------------------	--	-----------------------------------	------------------------------------	------------------------------------	------------------------

SPECIAL BAND-AL	mm	mm	m	Cod. Art./Item Code	€/pz	€/pz	€/pz	pz/pcs
-----------------	----	----	---	---------------------	------	------	------	--------

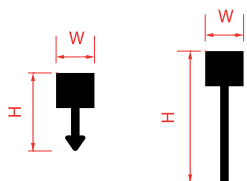
**ALLUMINIO ALUMINIUM**

	4,5X10	2,7	SPBA4510ANA27	5,98 €			10
			SPBA4510AAA27		7,98 €		
			SPBA4510ABA27			9,89 €	
	5X25		SPBA0525ANA27	8,74 €			
			SPBA0525AAA27		10,34 €		
			SPBA0525ABA27			12,24 €	

\* Note: Prodotto con disponibilità limitata. Verificare prima dell'ordine.

\* Note: Product with limited availability. Check before ordering.





SPECIAL  
PROFILES

## **Profili per gradini**

Stair nosing profiles



**PROFILI ALLUMINIO  
ANODIZZATO ARGENTO**  
 Silver Anodized  
 Aluminium Profiles

Dimensioni Size WxH	Lunghezza Length		Satinato Anodized AAA	Brillante Bright ABA	Quantità per conf. Pcs. box
mm	m	Cod. Art./Item Code	€/pz	€/pz	pz/pcs

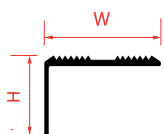
SPECIAL STEP-AL							
ALLUMINIO ALUMINIUM	25x20	2,7	SPST2520AAA27	12,45 €		10	
			SPST2520ABA27		19,16 €		
	42x26		SPST4226AAA27	17,19 €			
			SPST4226ABA27		25,49 €		

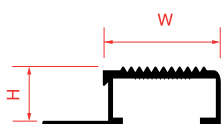

SPECIAL STEPSQ-AL							
ALLUMINIO ALUMINIUM	20x10	2,7	SPSS0010AAA27	27,20 €		10	
			SPSS0010ABA27		30,06 €		
	20x12,5		SPSS0012AAA27	28,98 €			
			SPSS0012ABA27		31,84 €		



SPECIAL STEPROUND-AL							
ALLUMINIO ALUMINIUM	10x10	2,7	SPSR0010AAA27	18,39 €		10	
			SPSR0010ABA27		20,62 €		
	10x12,5		SPSR0012AAA27	25,42 €			
			SPSR0012ABA27		28,28 €		

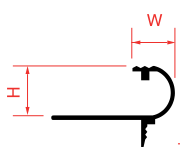



SPECIAL  
PROFILES



**Battiscopa**  
Skirting boards



AL

**SPECIAL  
PROFILES**
**Battiscopa**  
Skirting boards

**PROFILI ALLUMINIO  
ANODIZZATO ARGENTO**  
Silver Anodized  
Aluminium Profiles

Spessore Thickness <b>T</b>	Dimensioni Size <b>WxH</b>	Lunghezza Length		Satinato Anodized <b>AAA</b>	Brillante Bright <b>ABA</b>	Q.tà conf. Pcs. box
mm	mm	m	Cod. Art./Item Code	€/pz	€/pz	pz/pcs

**SPECIAL SKIRTING-AL**

ALLUMINIO ALUMINIUM

1,5	10x60	2	SPSK0060AAA27	16,09 €		10
			SPSK0060ABA27		23,41 €	

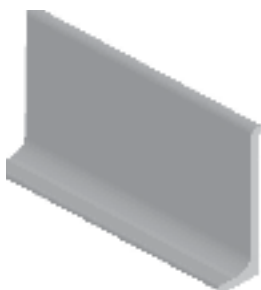

AC

**SPECIAL SKIRTING-AC\***

 ACCIAIO S-STEEL  
AISI 304

Spessore Thickness <b>T</b>	Dimensioni Size <b>WxHxT</b>	Lunghezza Length		Acciaio Lucido Polished S-Steel	Q.tà conf. Pcs. box
mm	mm	m	Cod. Art./Item Code	€/pz	pz/pcs

0,7	15x60	2	SPSK00607IL27	34,68 €	20
-----	-------	---	---------------	---------	----

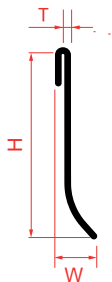

 \* Altre misure su richiesta  
\* Other sizes on request



SPECIAL  
PROFILES

## **Profili di raccordo igienici**

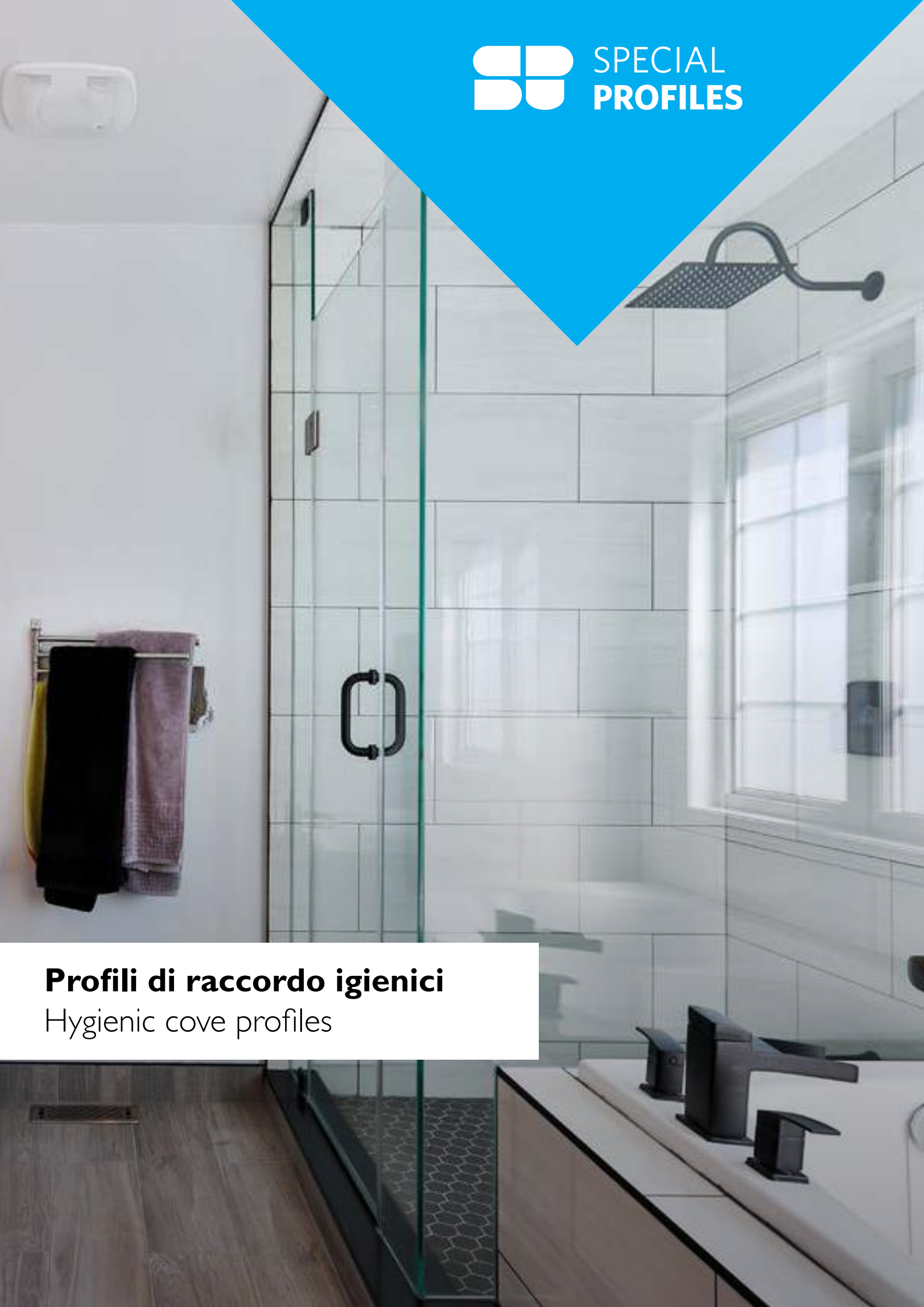
Hygienic cove profiles





**PROFILI ALLUMINIO  
ANODIZZATO ARGENTO**  
 Silver Anodized  
 Aluminium Profiles

Dimensioni <i>Size</i>	Lunghezza <i>Length</i>		Satinato Silver <b>AAA</b>	Brillante Bright Silver <b>ABA</b>	Quantità per conf. <i>Pcs. box</i>
mm	m	Cod. Art./Item Code	€/pz	€/pz	pz/pcs

SPECIAL SANIT-AL					
18x18	2,7	SPSA0020AAA27	14,96 €		10
		SPSA0020ABA27		17,31 €	

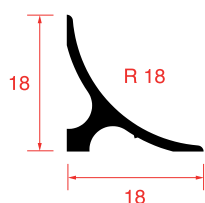
ALLUMINIO ALUMINIUM



SPECIAL PROTEC-AL	mm	m	Cod. Art./Item Code	€/pz	€/pz	pz/pcs
-------------------	----	---	---------------------	------	------	--------

ALLUMINIO ALUMINIUM

10x10	2,7	SPPR0010AAA27	15,72 €		10
		SPPR0010ABA27		24,49 €	

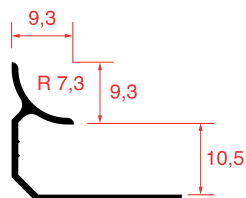

	Dimensioni Size <b>H</b>	Lunghezza Length		PVC bianco White PVC	Quantità per conf. Pcs. box
<b>SPECIAL SANIT-PVC</b>	mm	m	Cod. Art./Item Code	€/pz	pz/pcs

PVC PVC

45	2	SPSA4545PVB2	16,48 €	10
----	---	--------------	---------	----

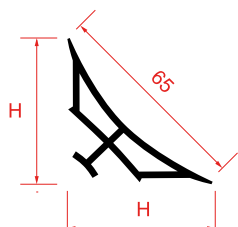

<b>SPECIALSANIT ANG-INT</b>	45		SPSA4545PVIN	12,52 €	10
-----------------------------	----	--	--------------	---------	----

PVC PVC



<b>SPECIALSANIT ANG-EST</b>	45		SPSA4545PVES	12,52 €	10
-----------------------------	----	--	--------------	---------	----

PVC PVC



<b>SPECIAL PROTEC-PVC</b>	8	2,6	SPPR0008PVB26	8,62 €	20
	10	2,6	SPPR0010PVB26	9,18 €	

PVC PVC

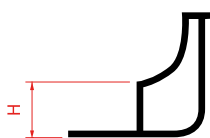

<b>SPECIAL CAPPI-PVC</b>	8		SPPI0008PB00	1,25 €	10
	10		SPPI0010PB01	1,25 €	

PVC PVC



<b>SPECIAL CAPPE-PVC</b>	8		SPPE0008PB00	1,25 €	10
	10		SPPE0010PB01	1,25 €	

PVC PVC

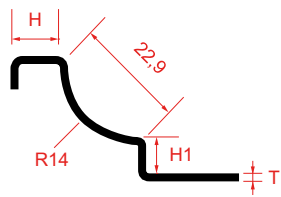

	Spessore Thickness T	Dimensioni Size H - H1	Lunghezza Length		Lucido Polished Steel	Spazzolato* Brushed	Quantità per conf. Pcs. box
<b>SPECIAL PROTEC-AC</b>	mm	mm	m	Cod. Art./Item Code	€/pz	€/pz	pz/pcs

 ACCIAIO AISI 304  
 STEEL AISI 304

0,7	08x08	2,7	SPSG08087IL27	71,56 €		10
			SPSG08087IS27		76,96 €	
	10x10		SPSG10107IL27	77,28 €		
			SPSG10107IS27		82,68 €	
	10x12,5		SPSG10127IL27	85,01 €		
			SPSG10127IS27		90,41 €	



\* Note: Prodotto con disponibilità limitata. Verificare prima dell'ordine.

\* Note: Product with limited availability. Check before ordering.

	Dimensioni Size <b>H</b>	Lunghezza Length		PVC bianco White PVC	Quantità per conf. Pcs. box
<b>SPECIAL SANIT-PVC</b>	mm	m	Cod. Art./Item Code	€/pz	pz/pcs
PVC PVC	20	2,5	SPSA2020PVB25	7,24 €	20

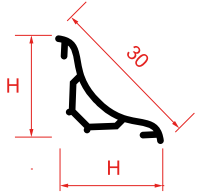

<b>SPECIAL CAPSI-PVC</b>	20x20		SPCI2020PB00	1,08 €	10
--------------------------	-------	--	--------------	--------	----

PVC PVC



<b>SPECIAL CAPSE-PVC</b>	20x20		SPCE2020PB00	1,08 €	10
--------------------------	-------	--	--------------	--------	----

PVC PVC



<b>SPECIAL SANIT-PVC</b>	20x20		SPTR2020PB00	1,08 €	10
--------------------------	-------	--	--------------	--------	----

PVC PVC





**SPECIAL  
PROFILES**

## **Profili per Balconi e Terrazzi**

Edging Profiles for Balconies and Terraces

SPECIAL BORD-AL	Dimensioni Size	Lunghezza Length	Cod. Art./Item Code	Naturale Natural ANA	Anodizzati Anodized	Profili Verniciati Ral Ral Painted Profiles				Quantità per conf. Pcs. box
					Argento Silver AAA	Bianco White 9010	Grigio Grey 7038	Beige Light Brown 1019	Marrone Brown 8019	

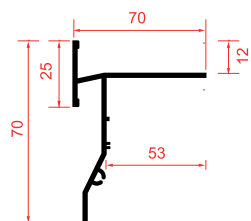
**ALLUMINIO ALUMINIUM**

70x70x12	2,7	SPSB0012ANA27	56,75 €							10
		SPSB0012AAA27		68,85 €						
		SPSB0012AVB27			68,85 €					
		SPSB0012AVG27				68,85 €				
		SPSB0012AVE27						68,85 €		
		SPSB0012AVM27							68,85 €	

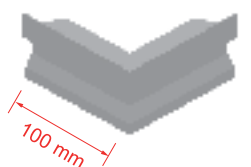
**SPECIAL BORDCORN-AL**
**ALLUMINIO ALUMINIUM**

100x45°	0,1	SPSC0012ANA10	26,13 €							5
		SPSC0012AAA10		28,55 €						
		SPSC0012AVB10			28,55 €					
		SPSC0012AVG10				26,68 €				
		SPSC0012AVE10						28,55 €		
		SPSC0012AVM10							26,68 €	

2 angoli già assemblati, da 100 mm, taglio 45°. 2 corners, 100 mm each, 45°, pre mounted.

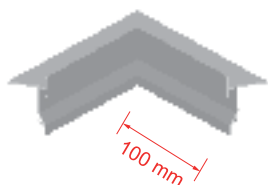
**SPECIAL BORDANG-AL**
**ALLUMINIO ALUMINIUM**

100x45°	0,1	SPSD0012ANA10	33,43 €							5
		SPSD0012AAA10		39,22 €						
		SPSD0012AVB10			39,22 €					
		SPSD0012AVG10				36,65 €				
		SPSD0012AVE10						39,22 €		
		SPSD0012AVM10							36,65 €	

2 angoli già assemblati, da 100 mm, taglio 45°. 2 corners, 100 mm each, 45°, pre mounted.

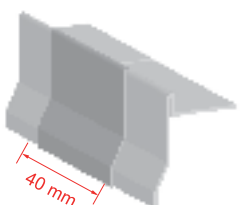
**SPECIAL BORDFLATCONN-AL**
**ALLUMINIO ALUMINIUM**

40	0,04	SPBN0001ANA04	5,35 €							50
		SPBN0001AAA04		7,06 €						
		SPBN0001AVB04			7,06 €					
		SPBN0001AVG04				7,06 €				
		SPBN0001AVE04						7,06 €		
		SPBN0001AVM04							7,06 €	

Dimensioni Size	Cod. Art./Item Code	Acciaio Lucido Polished S-Steel	Quantità per conf. Packing Quantity
mm		€/per conf.	pz/pcs

**ACCIAIO S-STEEL**

200xø4	SPSP0004IL20	52,43 €	50
--------	--------------	---------	----

Pin di connessione. Connection's Pin





NEW

SpecialBord	Dimensioni Size	Lunghezza Length	Cod. Art./Item Code	Anthracite Stone AGP	Bianco White Stone ABS	Beige Stone ABP	Q.tà conf. Pcs. box
SpecialBord	mm	m	Cod. Art./Item Code	€/pz	€/pz	€/pz	pz/pcs

## ALLUMINIO ALUMINIUM

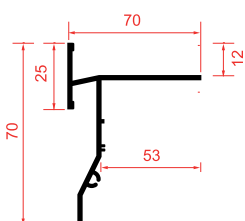

70x70x12	2,7	SPSB0012AGP27	78,07 €				10
		SPSB0012ABS27		78,07 €			
		SPSB0012ABP27			78,07 €		

## SpecialBordCorn-AL

## ALLUMINIO ALUMINIUM

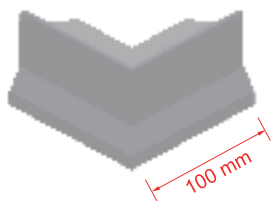

100x45°	0,1	SPSC0012AGP12	29,35 €				5
		SPSC0012ABS12		29,35 €			
		SPSC0012ABP12			29,35 €		

## SpecialBordAng-AL

## ALLUMINIO ALUMINIUM

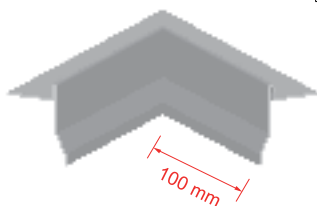

100x45°	0,1	SPDO0012AGP12	40,32 €				5
		SPDO0012ABS12		40,32 €			
		SPDO0012ABP12			40,32 €		

## SpecialBordConn-AL

## ALLUMINIO ALUMINIUM

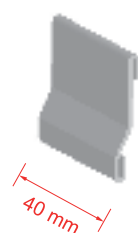

40x70x12	0,1	SPBN0012AGP04	7,39 €				50
		SPBN0012ABS04		7,39 €			
		SPBN0012ABP04			7,39 €		

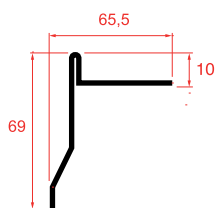

SpecialBordFlat-AL	Dimensioni Size	Lunghezza Length	Cod. Art./Item Code	Anodizzati Argento Silver Anodized	Profili Verniciati Ral Ral Painted Profiles				Quantità per conf. Pcs. box
				Satinato Silver AAA	Bianco White AVB	Grigio Grey AVG	Beige Light Brown AVE	Marrone Brown AVM	

**ALLUMINIO ALUMINIUM**

65,5x69x10	2,0	SPSF0010AAA27	43,07 €					10
		SPSF0010AVB27		43,07 €				
		SPSF0010AVG27			43,07 €			
		SPSF0010AVE27				43,07 €		
		SPSF0010AVM27					43,07 €	

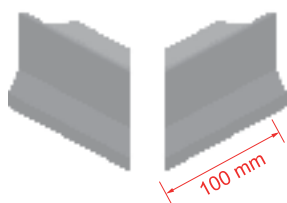
**SpecialBordFlatCorn-AL \***
**ALLUMINIO ALUMINIUM**

100x45°	0,1	SPBC0010AAA10	28,55 €					5
		SPBC0010AVB10		28,55 €				
		SPBC0010AVG10			28,55 €			
		SPBC0010AVE10				28,55 €		
		SPBC0010AVM10					28,55 €	

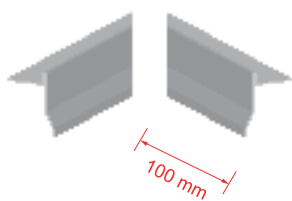
**SpecialBordFlatAng-AL \***
**ALLUMINIO ALUMINIUM**

100x45°	0,1	SPBG0010AAA10	37,08 €					5
		SPBG0010AVB10		37,08 €				
		SPBG0010AVG10			37,08 €			
		SPBG0010AVE10				37,08 €		
		SPBG0010AVM10					37,08 €	

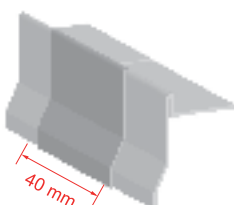
**SpecialBordFlatConn-AL**
**ALLUMINIO ALUMINIUM**

40	0,04	SPBN0010AAA04	7,06 €					50
		SPBN0010AVB04		7,06 €				
		SPBN0010AVG04			7,06 €			
		SPBN0010AVE04				7,06 €		
		SPBN0010AVM04					7,06 €	

\* ATTENZIONE: Gli angoli sono forniti in due pezzi separati

\* PLEASE NOTE: Corners are supplied in two separate pieces

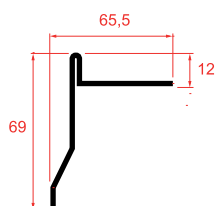

SpecialBordFlat-AL	Dimensioni Size	Lunghezza Length	Cod. Art./Item Code	Anodizzati Argento Silver Anodized	Profili Verniciati Ral Ral Painted Profiles				Quantità per conf.  Pcs. box
				Satinato Silver AAA	Bianco White 9010	Grigio Grey 7038	Beige Light Brown 1019	Marrone Brown 8019	

**ALLUMINIO ALUMINIUM**

65,5x69x12	2,0	SPSF0012AAA27	43,07 €						10
		SPSF0012AVB27		43,07 €					
		SPSF0012AVG27			43,07 €				
		SPSF0012AVE27				43,07 €			
		SPSF0012AVM27						43,07 €	

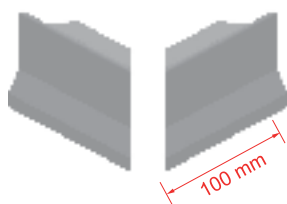
**SpecialBordFlatCorn-AL \***
**ALLUMINIO ALUMINIUM**

100x45°	0,1	SPBC0007AAA10	28,55 €						5
		SPBC0007AVB10		28,55 €					
		SPBC0007AVG10			28,55 €				
		SPBC0007AVE10				28,55 €			
		SPBC0007AVM10						28,55 €	

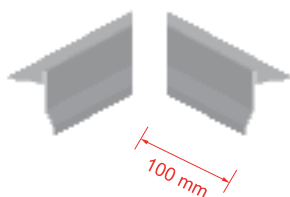
**SpecialBordFlatAng-AL \***
**ALLUMINIO ALUMINIUM**

100x45°	0,1	SPBG0007AAA10	37,08 €						5
		SPBG0007AVB10		37,08 €					
		SPBG0007AVG10			37,08 €				
		SPBG0007AVE10				37,08 €			
		SPBG0007AVM10						37,08 €	

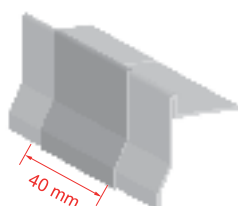
**SPECIAL BORDFLATCONN-AL**
**ALLUMINIO ALUMINIUM**

40	0,04	SPBN0007AAA04	7,06 €						50
		SPBN0007AVB04		7,06 €					
		SPBN0007AVG04			7,06 €				
		SPBN0007AVE04				7,06 €			
		SPBN0007AVM04						7,06 €	

\* ATTENZIONE: Gli angoli sono forniti in due pezzi non saldati  
 \* PLEASE NOTE: Corners are supplied in two pieces not welded

**NEW**

	Dimensioni Size	Lunghezza Length		Anthracite Stone <b>AGP</b>	Bianco White Stone <b>ABS</b>	Beige Stone <b>ABP</b>	Q.tà conf. Pcs. box
<b>SpecialBordFlat-AL</b>	mm	m	Cod. Art./Item Code	€/pz	€/pz	€/pz	pz/pcs

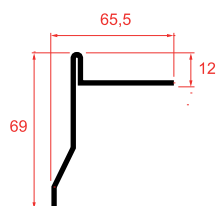
**ALLUMINIO ALUMINIUM**

65,5x69x10	2,0	SPSF0010AGP27	48,65 €				10
		SPSF0010ABS27		48,65 €			
		SPSF0010ABP27			48,65 €		
65,5x69x12		SPSF0012AGP27	48,65 €				
SPSF0012ABS27			48,65 €				
SPSF0012ABP27				48,65 €			

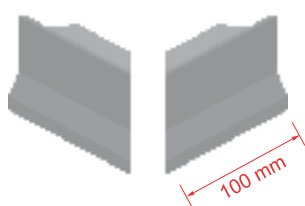
**SpecialBordFlatCorn-AL \***
**ALLUMINIO ALUMINIUM**

100x45°h10	0,1	SPBC0010AGP10	32,51 €				5
		SPBC0010ABS10		32,51 €			
		SPBC0010ABP10			32,51 €		
100x45°h12		SPBC0007AGP10	32,51 €				
SPBC0007ABS10			32,51 €				
SPBC0007ABP10				32,51 €			

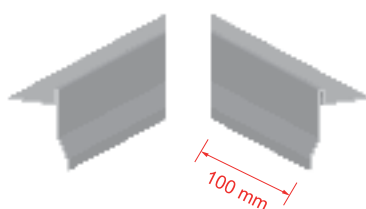
**SpecialBordFlatAng-AC \***
**ALLUMINIO ALUMINIUM**

100x45°h10	0,1	SPBG0010AGP10	39,85 €				5
		SPBG0010ABS10		39,85 €			
		SPBG0010ABP10			39,85 €		
100x45°h12		SPBG0007AGP10	39,85 €				
SPBG0007ABS10			39,85 €				
SPBG0007ABP10				39,85 €			

**SpecialBordFlatConn-AC**
**ALLUMINIO ALUMINIUM**

49x69xh10	0,1	SPBN0010AGP04	7,69 €				50
		SPBN0010ABS04		7,69 €			
		SPBN0010ABP04			7,69 €		
49x69xh12		SPBN0007AGP04	7,69 €				
SPBN0007ABP04			7,69 €				
SPBN0007ABP04				7,69 €			

\* ATTENZIONE: Gli angoli sono forniti in due pezzi separati

\* PLEASE NOTE: Corners are supplied in two separate pieces



	Dimensioni Size	Lunghezza Length		Acciaio Lucido Polished S-Steel	Q.tà conf. Pcs. box
SpecialBordFlat-AC	mm	m	Cod. Art./Item Code	€/pz	pz/pcs

ACCIAIO S-STEEL  
AISI 304

65,5x69x12	2,7	SPBF0007IL027	72,77 €	10
------------	-----	---------------	---------	----

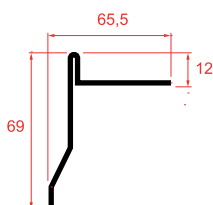

SpecialBordFlatCorn-AC \*

100x45°	0,1	SPBC0007IL10	44,99 €	5
---------	-----	--------------	---------	---

ACCIAIO S-STEEL  
AISI 304

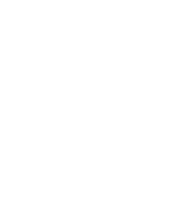
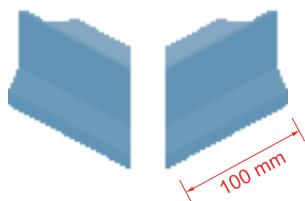

SpecialBordFlatAng-AC \*

100x45°	0,1	SPBG0007IL04	58,63 €	5
---------	-----	--------------	---------	---

ACCIAIO S-STEEL  
AISI 304

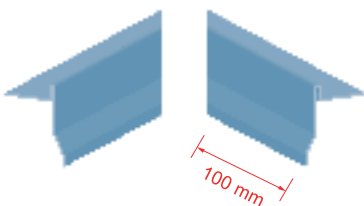

SpecialBordFlatConn-AC

40	0,4	SPBN0007IL04	8,35 €	50
----	-----	--------------	--------	----

ACCIAIO S-STEEL  
AISI 304

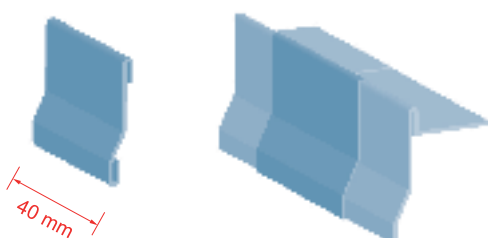

\* ATTENZIONE: Gli angoli sono forniti in due pezzi separati  
\* PLEASE NOTE: Corners are supplied in two separate pieces



SPECIAL  
PROFILES

## **Profili per il bagno**

Draining and shower systems

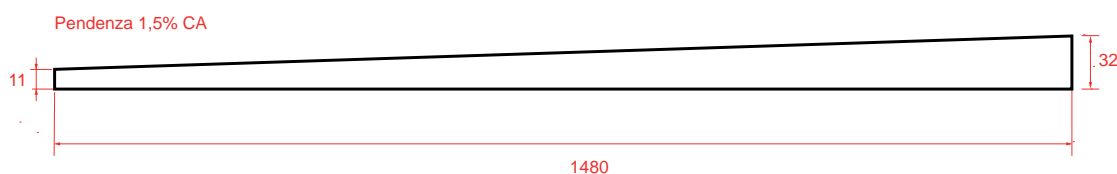
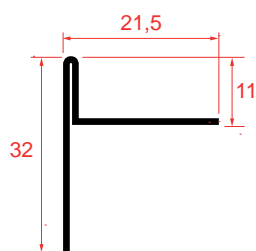

## SPECIAL DRAIN

ACCIAIO S-STEEL  
AISI 304

Dimensioni Size		Finitura	Lunghezza	Installazione	
mm	Cod. Art./Item Code		cm		€/pz



32x21x10,3	SPCP3207IS148D	Spazzolato	148	destra	75,76 €
32x21x10,3	SPCP3207IS148S	Spazzolato	148	sinistra	76,76 €
32x21x10,3	SPCP3207IL148S	Lucido	148	sinistra	70,09 €
32x21x10,3	SPCP3207IL148D	Lucido	148	destra	70,09 €



Profilo mono-pendenza in acciaio inox (AISI 304) per il pavimento in pendenza della doccia all'italiana. Copre perfettamente la parte inclinata(2%) non piastrellata ed evita il verificarsi di infiltrazioni. Non è più necessario tagliare le piastrelle a misura per coprire la parte inclinata non piastrellata . Disponibile per il lato destro e sinistro. Attenzione: per accorciare il profilo, tagliarlo nel punto più alto. Istruzioni per la pulizia: non pulire mai l'acciaio inox con materiali abrasivi ed i detergenti non devono contenere cloro o acido cloridrico.

*Inclined-wedge in stainless steel (AISI 304) for the shower sloping floor. It perfectly covers the non-tiled sloping part (2%) and prevents infiltrations. It is no longer necessary to cut the tiles to size to cover the non-tiled sloping part. Available for left and right side.*

*Attention: to shorten the profile, cut it at the highest point.*

*Cleaning instructions: never clean stainless steel with abrasive materials and detergents must not contain chlorine or hydrochloric acid*

SPECIAL DRAIN	Dimensioni Size	Cod. Art./Item Code	€/pz	Quantità per conf. Pcs. box
	mm			pz/pcs

**ACCIAIO S-STEEL**

100x100	SPCD1010IL00	14,83 €	16
---------	--------------	---------	----

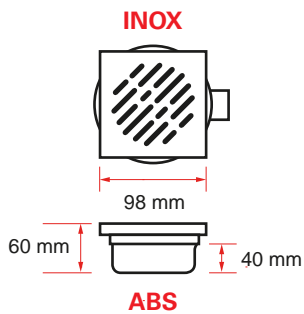

**CHIUSINO 10X10 REGOLABILE CON GRIGLIA INOX**  
Corpo e sifone in ABS, Griglia in acciaio inox.

**ADJUSTABLE 10x10 FLOOR DRAIN WITH INOX GRATING**  
Body and siphon in ABS - Grating in stainless steel Aisi 304



**SPECIAL DRAIN**

**ACCIAIO S-STEEL**

130x130	SPCD1313IL00	48,38 €	12
---------	--------------	---------	----

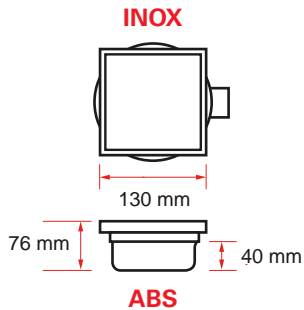

**CHIUSINO REGOLABILE CON PORTAPIASTRELLA INOX**  
Acciaio 130x130  
**ADJUSTABLE INOX FLOOR DRAIN**  
with tile tray 130x130



**SPECIAL DRAIN**

**ABS ABS**

130x130	SPCD1313PV00	11,30 €	20
---------	--------------	---------	----

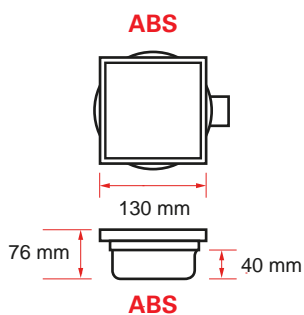

**CHIUSINO REGOLABILE CON PORTAPIASTRELLA ABS**  
ABS 130x130  
**ADJUSTABLE ABS FLOOR DRAIN**  
with tile tray 130x130





Dimensioni Size	Portata Water flow			Quantità per conf. Pcs. box
mm	lpm	Cod. Art./Item Code	€/pz	pz/pcs

<b>SPECIAL DRAIN</b>					
<b>ACCIAIO S-STEEL</b>	100x100	200	SPCD1010ILOG	135,89 €	1

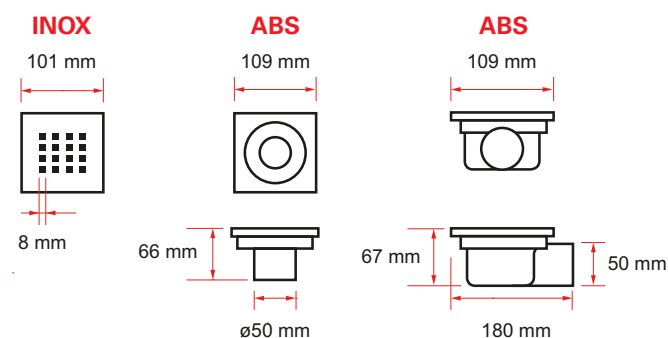

**CHIUSINO 10x10 PER DOCCIA INOX**

Griglia 16 fori, vaschetta e corpo sifonato

**SHOWER DRAIN 10x10 INOX**

16 holes grid, drain body and siphon body

Il Kit comprende il corpo sifonato, il foglio di guaina impermeabilizzante con adattatore incorporato, la vaschetta, il filtro e la griglia.

Materiale:

- Vaschetta in PVC
- Corpo sifonato e filtro in ABS
- Griglia e cornice della vaschetta in Acciaio INOX

The kit includes the siphon body, the waterproofing sheet with builtin adapter, the drain body, the filter and the grid.

Material:

Drain body, adapter and filter in ABS.

Grid and body frame in stainless steel AISI 304.

Waterproofing sheet composed of two external layers of polypropylene + an inner layer of polyethylene.



Chiavetta per la rimozione della groglia inclusa  
Key for removing the grille included

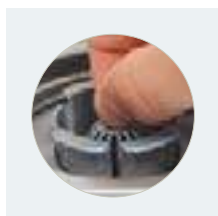

Filtro rimovibile  
Removable filter



Uscita ø50  
Ø50 outlet

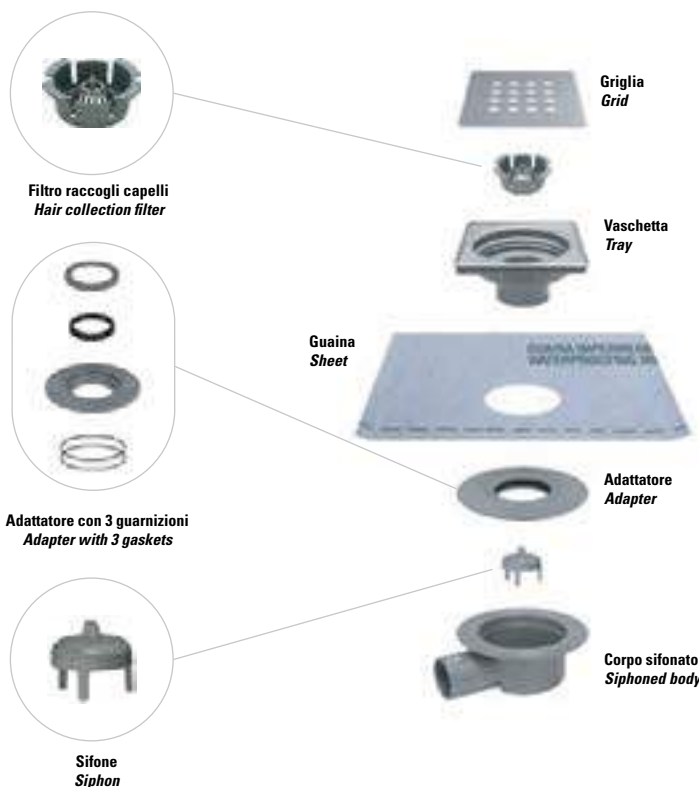

Dimensioni Size	Portata Water flow			Quantità per conf. Pcs. box
mm	lpm	Cod. Art./Item Code	€/pz	pz/pcs

<b>SPECIAL LINEARG</b>				
<b>ACCIAIO S-STEEL</b>	656x52	200	SPCL0065ILOG	233,26 €
				1

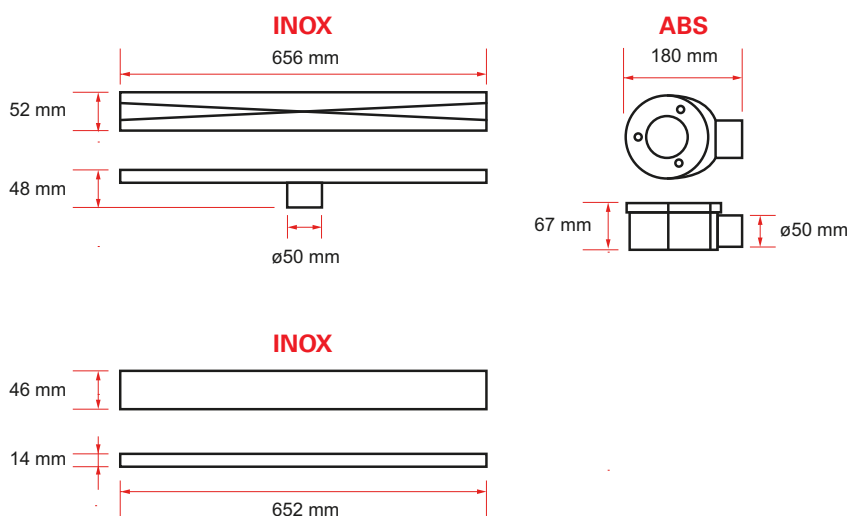

**CANALETTA PER DOCCIA CON GRIGLIA INOX**  
**LINEAR SHOWER DRAIN WITH INOX GRATING**

Il Kit comprende il corpo sifonato, il foglio di guaina impermeabilizzante con adattatore incorporato, la vaschetta, il filtro e la griglia.

Materiale:

- Vaschetta in PVC
- Corpo sifonato e filtro in ABS
- Griglia e cornice della vaschetta in Acciaio INOX
- Waterproofing sheet composed of two external layers of polypropylene + an inner layer of polyethylene.

*The kit includes the siphon body, the waterproofing sheet with builtin adapter, the drain body, the filter and the grid.*

Material:

- Drain body, adapter and filter in ABS.
- Grid and body frame in stainless steel AISI 304.
- Waterproofing sheet composed of two external layers of polypropylene + an inner layer of polyethylene.

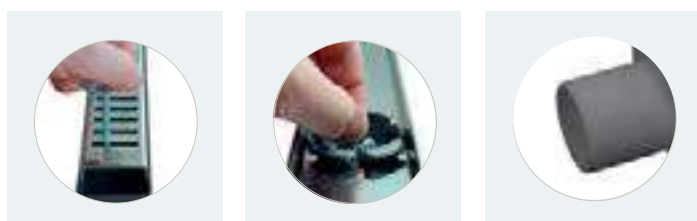

Chiavetta per la rimozione della griglia inclusa  
Key for grille removal included

Filtro rimovibile  
Removable filter

Uscita ø50  
Ø50 outlet



**Disponibili anche le lunghezze 550 mm - 750 mm - 850 mm - 950 mm (minimo 5 pezzi)**  
**Other length available 550 mm - 750 mm - 850 mm - 950 mm (minimum 5 pieces)**

Dimensioni Size	Portata Water flow			Quantità per conf. Pcs. box
mm	lpm	Cod. Art./Item Code	€/pz	pz/pcs

<b>SPECIAL LINEARG</b>				
<b>ACCIAIO S-STEEL</b>	658x53	200	SPCLA065ILOG	107,00 €
				1

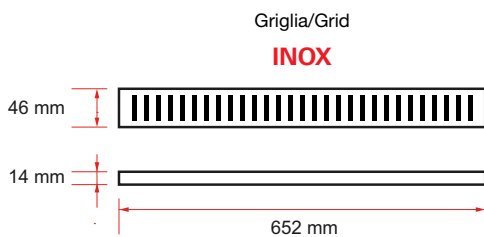
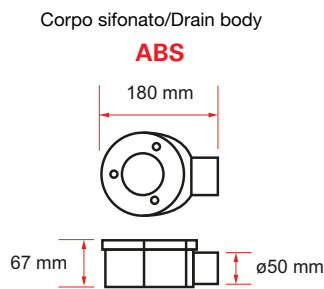
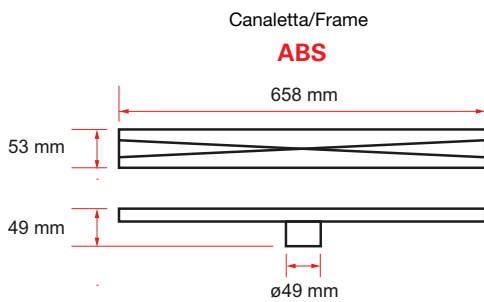

**CANALETTA PER DOCCIA CON GRIGLIA INOX**  
**LINEAR SHOWER DRAIN WITH INOX GRATING**

Il Kit comprende il corpo sifonato, il foglio di guaina impermeabilizzante con adattatore incorporato, la vaschetta, il filtro e la griglia.

Materiale:

- Vaschetta in PVC
- Corpo sifonato, canaletta e filtro in ABS
- Griglia INOX
- Waterproofing sheet composed of two external layers of polypropylene + an inner layer of polyethylene.

The kit includes the siphon body, the waterproofing sheet with builtin adapter, the drain body, the filter and the grid.

Materiale:

- Drain body, frame adapter and filter in ABS.
- Grid in stainless steel AISI 304.
- Waterproofing sheet composed of two external layers of polypropylene + an inner layer of polyethylene.

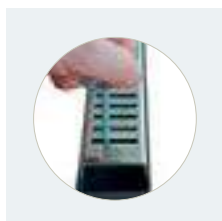

Chiavetta per la rimozione della griglia inclusa  
Key for grille removal included

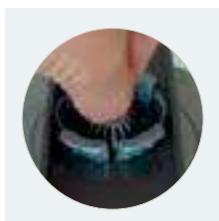

Filtro rimovibile  
Removable filter

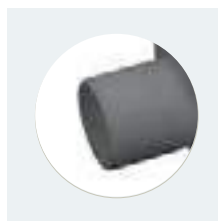

Uscita ø50  
Ø50 outlet



Filtro raccogli capelli  
Hair collection filter



Corpo sifonato con guarnizione  
Siphoned body with gasket



Corpo sifonato  
Siphoned body

Dimensioni Size	Portata Water flow			Quantità per conf. Pcs. box
mm	lpm	Cod. Art./Item Code	€/pz	pz/pcs

<b>SPECIAL LINEARPG</b>				
<b>ACCIAIO S-STEEL</b>	656x52	200	SPCL0065ILPG	242,89 €
				1

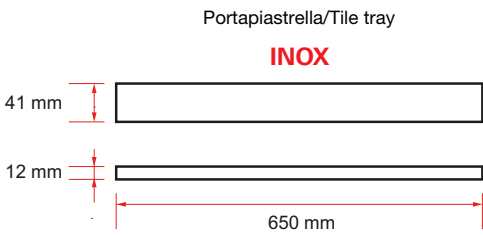
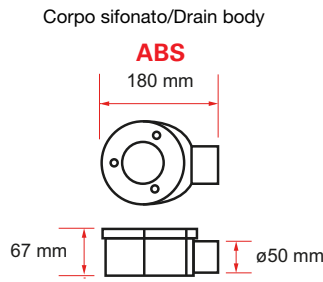
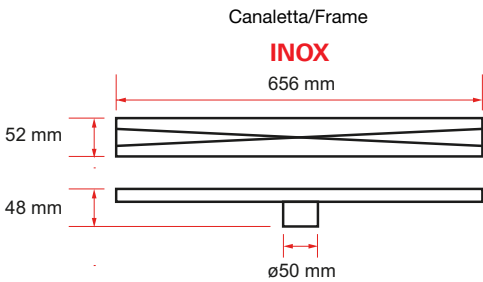

**CANALETTA PER DOCCIA CON PORTAPIASTRELLE INOX  
LINEAR SHOWER DRAIN WITH INOX TILE TRAY**

Il Kit comprende il corpo sifonato, il foglio di guaina impermeabilizzante con adattatore incorporato, la vaschetta, il filtro e il portapiastrelle.

Materiale:

- Corpo sifonato e filtro in ABS
- Canaletta e portapiastrella in Acciaio INOX

*The kit includes the siphon body, the waterproofing sheet with builtin adapter, the drain body, the filter and the tile tray.*

*Material:*

- Drain body, adapter and filter in ABS.
- Tile tray and body frame in stainless steel AISI 304.
- Waterproofing sheet composed of two external layers of polypropylene + an inner layer of polyethylene.

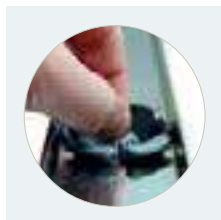

Filtro rimovibile  
Removable filter



Uscita ø50  
Ø50 outlet

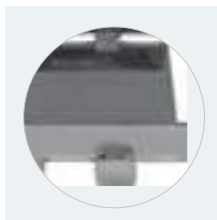

Il porta piastrella è dotato di fermi in gomma  
The tile holder is equipped with rubber stops



Disponibili anche le lunghezze 550 mm - 750 mm - 850 mm - 950 mm (minimo 5 pezzi)  
Other length available 550 mm - 750 mm - 850 mm - 950 mm (minimum 5 pieces)

	Dimensioni Size	Portata Water flow			Quantità per conf. Pcs. box
<b>SPECIAL LINEARPG</b>	mm	lpm	Cod. Art./Item Code	€/pz	pz/pcs
<b>ACCIAIO S-STEEL</b>	658x53	200	SPCLA065ILPG	119,84 €	1

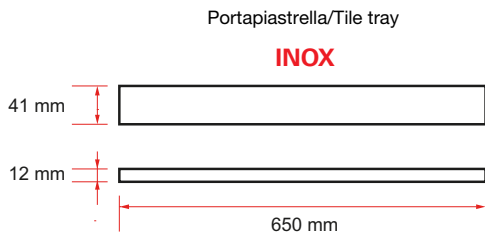
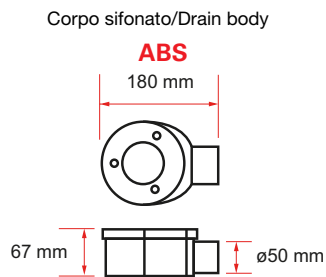
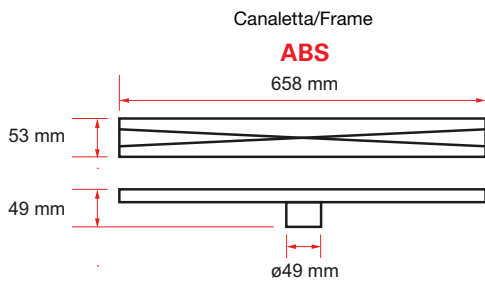

**CANALETTA PER DOCCIA CON PORTAPIASTRELLA INOX  
LINEAR SHOWER DRAIN WITH INOX TILE TRAY**

Il Kit comprende il corpo sifonato, il foglio di guaina impermeabilizzante con adattatore incorporato, la vaschetta, il filtro e il portapiastrella.

Materiale:

- Corpo sifonato, canaletta e filtro in ABS
- Portapiastrella in INOX

*The kit includes the siphon body, the waterproofing sheet with builtin adapter, the drain body, the filter and the tile tray.*

*Material:*

- Drain body, adapter frame and filter in ABS.
- Tile tray in stainless steel AISI 304.



Filtro rimovibile  
Removable filter



Uscita ø50  
Ø50 outlet





**Giunti di Dilatazione, accessori per la posa**

Movement joints – Accessories for laying



	Larghezza Width <b>T</b>	Altezza Height <b>H</b>	Lunghezza Length		PVC grigio/trasparente Grey/transparent PVC	Quantità per conf. Pcs. box
<b>SPECIAL FLEX-PVC</b>	mm	mm	m	Cod. Art./Item Code	€/pz	pz/pcs

PVC PVC

8	8	2	SPFX0808PVG2	2,82 €	50
	10		SPFX1008PVG2	2,93 €	
	12		SPFX1208PVG2	3,02 €	
	14		SPFX1408PVG2	3,66 €	

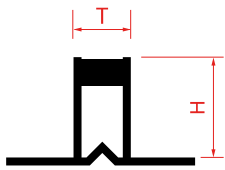

	Spessore Thickness <b>S</b>		PVC grigio Grey PVC	Quantità per conf. Pcs. box	Quantità per busta Pcs. bags
<b>SPECIAL DCROSS-PVC</b>	mm	Cod. Art./Item Code	€/busta/bag	pz/pcs	pz/pcs

PVC PVC

1	SPDC0001PVG	2,15 €	80	250
2	SPDC0002PVG	2,15 €	80	250
3	SPDC0003PVG	2,29 €	68	250
4	SPDC0004PVG	2,43 €	63	250
5	SPDC0005PVG	2,57 €	60	250
7	SPDC0007PVG	3,54 €	30	250
10	SPDC0010PVG	5,76 €	20	250

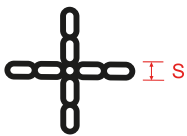

<b>SPECIAL DTI-PVC</b>					

PVC PVC

2	SPDT0002PVG	2,15 €	80	250
3	SPDT0003PVG	2,29 €	68	250
4	SPDT0004PVG	2,43 €	63	250
5	SPDT0005PVG	2,57 €	60	250
7	SPDT0007PVG	3,54 €	30	250
10	SPDT0010PVG	5,75 €	20	250



	Dimensioni Size <b>S</b>		PVC PVC	Quantità per conf. Pcs. box
<b>SPECIAL-DCU-PVC</b>	mm	Cod. Art./Item Code	€/busta/bag	pz/pcs

PVC PVC

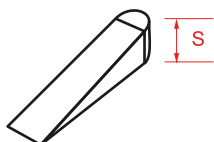

0-5	SPDU0005PVG	4,75 €	40 buste da 500 pz 40 bag-500 pcs/bag
0-10	SPDU0010PVG	8,84 €	16 buste da 500 pz 16 bag-500 pcs/bag

## Distanziatori autolivellanti

Self leveling spacers

	Dimensioni Size <b>S</b>		PVC PVC	Quantità per conf. Pcs. box
<b>SPECIAL-DCUX-PVC</b>	mm	Cod. Art./Item Code	€/busta/bag	pz/pcs

PVC PVC

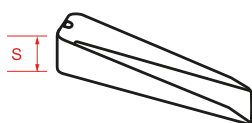

22	SPDU0022PVG	31,68 €	4 buste da 250 pz 4 bag-250 pcs/bag
----	-------------	---------	--

Altezza mattonelle Tiles height	Dimensioni Size <b>S</b>	Colore Colours		PVC PVC	Quantità per conf. Pcs. box
mm			Cod. Art./Item Code	€/busta/bag	pz/pcs

<b>SPECIAL-TC-PVC</b>					
	3-12	0,5	verde/green	SPDR0005PVG	18,83 €
	3-12	1	grigio/grey	SPDR0001PVG	17,66 €
	3-12	1,5	blu/bleu	SPDR0015PVG	18,83 €
	3-12	2	bianco/white	SPDR0002PVG	17,66 €
	3-12	3	giallo/yellow	SPDR0003PVG	20,01 €
	10-20	2	arancio/orange	SPDR0020PVG	23,54 €
					10 buste da 250 pz 10 bag-250 pcs/bag
					8 buste da 250 pz 8 bag-250 pcs/bag

PVC PVC

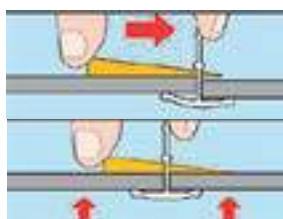
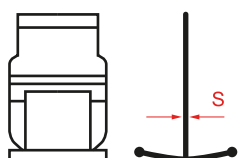





SPECIAL  
PROFILES

## **Profili in Alluminio per il Fai da Te**

Aluminium Do It Yourself Profiles

**PROFILI ALLUMINIO  
ANODIZZATO ARGENTO**  
Silver Anodized  
Aluminium Profiles

**PIATTO**  
FLAT BAR

Spessore Thickness <b>T</b>	Dimensioni Size <b>W</b>	Lunghezza Length	completa il cod. art. (xxx) con il tipo di finitura complete item code (xxx) with the finish type	Naturale Natural	Satinato Anodized	Brillante Bright	Verniciato Bianco White painted	Quantità per conf. Pcs. box
				(ANA)	(AAA)	(ABA)	(AVB)	
mm	mm	m	Cod. Art./Item Code	€/pz	€/pz	€/pz	€/pz	pz/pcs

**ALLUMINIO ALUMINIUM**

2	10	1	SPPI1002xxx01	1,24 €	2,08 €	3,19 €	3,04 €	10
		2	SPPI1002xxx02	2,49 €	4,15 €	6,38 €	6,07 €	
		3	SPPI1002xxx03	3,84 €	6,40 €	9,83 €	10,12 €	
	12	1	SPPI1202xxx01	1,46 €	2,27 €	3,43 €	3,25 €	
		2	SPPI1202xxx02	2,91 €	4,54 €	6,87 €	6,49 €	
		3	SPPI1202xxx03	4,49 €	7,00 €	10,59 €	10,81 €	
	15	1	SPPI1502xxx01	1,76 €	2,57 €	3,79 €	3,54 €	
		2	SPPI1502xxx02	3,52 €	5,14 €	7,58 €	7,08 €	
		3	SPPI1502xxx03	5,42 €	7,92 €	11,68 €	11,82 €	
	20	1	SPPI2002xxx01	2,28 €	3,06 €	4,38 €	4,06 €	
		2	SPPI2002xxx02	4,57 €	6,12 €	8,75 €	8,12 €	
		3	SPPI2002xxx03	7,04 €	9,44 €	13,50 €	13,51 €	
	25	1	SPPI2502xxx01	2,80 €	3,55 €	4,96 €	4,57 €	
		2	SPPI2502xxx02	5,60 €	7,10 €	9,93 €	9,13 €	
		3	SPPI2502xxx03	8,63 €	10,96 €	15,31 €	15,19 €	
	30	1	SPPI3002xxx01	3,32 €	4,04 €	5,55 €	5,07 €	
		2	SPPI3002xxx02	6,63 €	8,09 €	11,11 €	10,14 €	
		3	SPPI3002xxx03	10,21 €	12,47 €	17,13 €	16,88 €	
	35	1	SPPI3502xxx01	3,82 €	4,54 €	6,15 €	5,57 €	
		2	SPPI3502xxx02	7,64 €	9,07 €	12,31 €	11,13 €	
		3	SPPI3502xxx03	11,76 €	13,99 €	18,98 €	17,01 €	
	40	1	SPPI4002xxx01	4,33 €	5,03 €	6,74 €	6,07 €	
		2	SPPI4002xxx02	8,67 €	10,06 €	13,48 €	12,14 €	
		3	SPPI4002xxx03	13,35 €	15,51 €	20,79 €	20,25 €	
50	1	SPPI5002xxx01	5,38 €	6,01 €	7,92 €	7,10 €		
	2	SPPI5002xxx02	10,75 €	12,03 €	15,84 €	14,19 €		
	3	SPPI5002xxx03	16,56 €	18,55 €	24,42 €	23,63 €		

Completare il Cod. Art. con il tipo di finitura: es. Alluminio Naturale (ANA) -> SPPI0802ANA01  
Complete item code with the finish type: e.g. for Natural Aluminium (ANA) -> SPPI0802ANA01

**PROFILI ALLUMINIO  
ANODIZZATO ARGENTO**  
Silver Anodized  
Aluminium Profiles

**ANGOLARE**  
EQUAL SIDED ANGLE

Spessore Thickness <b>T</b>	Dimensioni Size <b>W</b>	Lunghezza Length <b>L</b>	completa il cod. art. (xxx) con il tipo di finitura complete item code (xxx) with the finish type	Naturale Natural	Satinato Anodized	Brillante Bright	Verniciato Bianco White painted	Quantità per conf. Pcs. box
				(ANA)	(AAA)	(ABA)	(AVB)	
mm	mm	m	Cod. Art./Item Code	€/pz	€/pz	€/pz	€/pz	pz/pcs

## ALLUMINIO ALUMINIUM

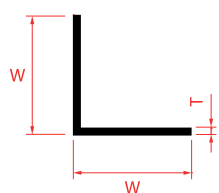

1	10	1	SPAN1010xxx01	1,20 €	2,02 €	3,14 €	2,99 €	10	
		2	SPAN1010xxx02	2,39 €	4,04 €	6,26 €	5,97 €		
		3	SPAN1010xxx03	3,68 €	6,25 €	9,66 €	9,96 €		
	15	1	SPAN1515xxx01	1,71 €	2,51 €	3,73 €	3,50 €		
		2	SPAN1515xxx02	3,43 €	5,04 €	7,46 €	7,00 €		
		3	SPAN1515xxx03	5,28 €	7,77 €	11,51 €	11,65 €		
	20	1	SPAN2020xxx01	2,23 €	3,02 €	4,32 €	4,00 €		
		2	SPAN2020xxx02	4,46 €	6,02 €	8,63 €	8,01 €		
		3	SPAN2020xxx03	6,87 €	9,30 €	13,32 €	13,35 €		
	25	1	SPAN2525xxx01	2,74 €	3,51 €	4,91 €	4,51 €		
		2	SPAN2525xxx02	5,49 €	7,01 €	9,81 €	9,02 €		
		3	SPAN2525xxx03	8,45 €	10,80 €	15,14 €	15,03 €		
	30	1	SPAN3030xxx01	3,20 €	3,95 €	5,44 €	4,96 €		
		2	SPAN3030xxx02	6,41 €	7,89 €	10,89 €	9,92 €		
		3	SPAN3030xxx03	9,88 €	12,18 €	16,79 €	16,54 €		
	1,5	40	1	SPAN4040xxx01	6,32 €	6,92 €	9,02 €		8,02 €
			2	SPAN4040xxx02	12,64 €	13,85 €	18,03 €		16,05 €
			3	SPAN4040xxx03	19,47 €	21,34 €	27,81 €		26,73 €
50		1	SPAN5050xxx01	7,87 €	8,40 €	10,80 €	9,55 €		
		2	SPAN5050xxx02	15,75 €	16,81 €	21,58 €	19,10 €		
		3	SPAN5050xxx03	24,25 €	25,92 €	33,29 €	31,81 €		

Completare il Cod. Art. con il tipo di finitura: es. Alluminio Naturale (ANA) -> SPPI0802ANA01  
Complete item code with the finish type: e.g. for Natural Aluminium (ANA) -> SPPI0802ANA01

**PROFILI ALLUMINIO  
ANODIZZATO ARGENTO**  
Silver Anodized  
Aluminium Profiles

**"L"**  
UN-EQUAL SIDED ANGLE

Spessore Thickness <b>T</b>	Dimensioni Size <b>WxH</b>	Lunghezza Length	completa il cod. art. (xxx) con il tipo di finitura complete item code (xxx) with the finish type	Naturale Natural	Satinato Anodized	Brillante Bright	Verniciato Bianco White painted	Quantità per conf. Pcs. box
				(ANA)	(AAA)	(ABA)	(AVB)**	
mm	mm	m	Cod. Art./Item Code	€/pz	€/pz	€/pz	€/pz	pz/pcs

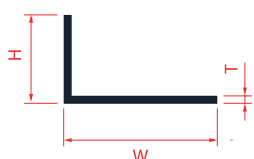
**ALLUMINIO ALUMINIUM**

1	15x10	1	SPEL1510xxx01	1,46 €	2,27 €	3,43 €	3,25 €	10
		2	SPEL1510xxx02	2,91 €	4,55 €	6,86 €	6,49 €	
		3	SPEL1510xxx03	4,47 €	7,01 €	10,59 €	10,81 €	
	20x10	1	SPEL2010xxx01	1,71 €	2,51 €	3,73 €	3,50 €	
		2	SPEL2010xxx02	3,43 €	5,04 €	7,45 €	7,00 €	
		3	SPEL2010xxx03	5,28 €	7,77 €	11,50 €	11,65 €	
	25x15	1	SPEL2515xxx01	2,23 €	3,02 €	4,32 €	4,00 €	
		2	SPEL2515xxx02	4,46 €	6,02 €	8,63 €	8,01 €	
		3	SPEL2515xxx03	6,87 €	9,30 €	13,32 €	13,35 €	
	30x15	1	SPEL3015xxx01	2,49 €	3,26 €	4,61 €	4,26 €	
		2	SPEL3015xxx02	4,97 €	6,52 €	9,22 €	8,51 €	
		3	SPEL3015xxx03	7,67 €	10,05 €	14,23 €	14,53 €	
	30x20	1	SPEL3020xxx01	2,74 €	3,51 €	4,91 €	4,51 €	
		2	SPEL3020xxx02	5,50 €	7,02 €	9,81 €	9,03 €	
		3	SPEL3020xxx03	8,46 €	10,81 €	15,14 €	15,04 €	
	40x10	1	SPEL4010xxx01	2,74 €	3,51 €	4,91 €	4,51 €	
		2	SPEL4010xxx02	5,50 €	7,02 €	9,81 €	9,03 €	
		3	SPEL4010xxx03	8,46 €	10,81 €	15,14 €	15,04 €	
	40x15	1	SPEL4015xxx01	2,99 €	3,75 €	5,20 €	4,75 €	
		2	SPEL4015xxx02	5,99 €	7,49 €	10,40 €	9,52 €	
		3	SPEL4015xxx03	9,22 €	11,54 €	16,05 €	15,85 €	

\* Articolo a richiesta. Ordine minimo 100 pz  
\* Article on request. Minimum order 100 pcs

Completare il Cod. Art. con il tipo di finitura: es. Alluminio Naturale (ANA) -> SPPI0802ANA01  
Complete item code with the finish type: e.g. for Natural Aluminium (ANA) -> SPPI0802ANA01

**PROFILI ALLUMINIO  
ANODIZZATO ARGENTO**  
Silver Anodized  
Aluminium Profiles

**"U"**  
U PROFILE

Spessore Thickness <b>T</b>	Dimensioni Size <b>WxH</b>	Lunghezza Length	completa il cod. art. ( <b>xxx</b> ) con il tipo di finitura complete item code ( <b>xxx</b> ) with the finish type	Naturale <i>Natural</i>	Satinato <i>Anodized</i>	Brillante <i>Bright</i>	Verniciato Bianco White painted	Quantità per conf. Pcs. box
				( <b>ANA</b> )	( <b>AAA</b> )	( <b>ABA</b> )	( <b>AVB</b> )* **	
mm	mm	m	Cod. Art./Item Code	€/pz	€/pz	€/pz	€/pz	pz/pcs

## ALLUMINIO ALUMINIUM

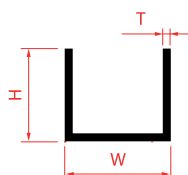

1	8x8	1	SPCU0808xxx01	1,36 €	2,18 €	3,31 €	3,15 €	10
		2	SPCU0808xxx02	2,70 €	4,34 €	6,62 €	6,28 €	
		3	SPCU0808xxx03	4,16 €	6,70 €	10,21 €	10,47 €	
	10x10	1	SPCU1010xxx01	1,67 €	2,47 €	3,67 €	3,45 €	
		2	SPCU1010xxx02	3,32 €	4,93 €	7,33 €	6,89 €	
		3	SPCU1010xxx03	5,11 €	7,61 €	11,32 €	11,48 €	
	10x15	1	SPCU1015xxx01	2,18 €	2,96 €	4,26 €	3,96 €	
		2	SPCU1015xxx02	4,35 €	5,92 €	8,52 €	7,90 €	
		3	SPCU1015xxx03	6,70 €	9,14 €	13,15 €	13,17 €	
	12x12	1	SPCU1212xxx01	1,99 €	2,80 €			
		2	SPCU1212xxx02	3,94 €	5,58 €			
		3	SPCU1212xxx03	6,09 €	8,62 €			
	15x10	1	SPCU1510xxx01	1,93 €	2,72 €	3,97 €	3,71 €	
		2	SPCU1510xxx02	3,83 €	5,42 €	7,92 €	7,39 €	
		3	SPCU1510xxx03	5,91 €	8,37 €	12,22 €	12,32 €	
	15x15	1	SPCU1515xxx01	2,43 €	3,20 €	4,56 €	4,20 €	
		2	SPCU1515xxx02	4,87 €	6,42 €	9,11 €	8,42 €	
		3	SPCU1515xxx03	7,49 €	9,89 €	14,05 €	14,00 €	
	20x20	1	SPCU2020xxx01	3,20 €	3,95 €	5,44 €	4,96 €	
		2	SPCU2020xxx02	6,41 €	7,89 €	10,89 €	9,92 €	
		3	SPCU2020xxx03	9,88 €	12,18 €	16,79 €	16,54 €	

\* Articolo a richiesta. Ordine minimo 100 pz

\* Article on request. Minimum order 100 pcs

Completare il Cod. Art. con il tipo di finitura: es. Alluminio Naturale (**ANA**) -> SPPI0802**ANA**01Complete item code with the finish type: e.g. for Natural Aluminium (**ANA**) -> SPPI0802**ANA**01

**PROFILI ALLUMINIO  
ANODIZZATO ARGENTO**  
 Silver Anodized  
 Aluminium Profiles

**DOPPIA "U"**  
*UU PROFILE*

Spessore Thickness <b>T</b>	Dimensioni Size <b>WxH</b>	Lunghezza Length <b>L</b>	completa il cod. art. ( <b>xxx</b> ) con il tipo di finitura <i>complete item code (<b>xxx</b>) with the finish type</i>	Naturale <i>Natural</i>	Satinato <i>Anodized</i>	Brillante <i>Bright</i>	Verniciato Bianco White painted	Quantità per conf. <i>Pcs. box</i>
				( <b>ANA</b> )	( <b>AAA</b> )	( <b>ABA</b> )	( <b>AVB</b> )* **	
mm	mm	m	Cod. Art./Item Code	€/pz	€/pz	€/pz	€/pz	pz/pcs

## ALLUMINIO ALUMINIUM

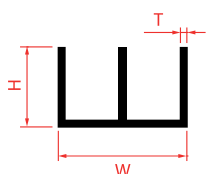

1	16x7	1	SPUU1607xxx01	2,43 €	3,20 €	4,56 €	4,20 €	10
		2	SPUU1607xxx02	4,87 €	6,42 €	9,11 €	8,42 €	
		3	SPUU1607xxx03	7,49 €	9,89 €	14,05 €	14,00 €	
	16x12	1	SPUU1612xxx01	2,74 €	3,51 €	4,91 €	4,51 €	
		2	SPUU1612xxx02	5,49 €	7,01 €	9,81 €	9,03 €	
		3	SPUU1612xxx03	8,45 €	10,80 €	15,14 €	15,04 €	
	20x10	1	SPUU2010xxx01	2,63 €	3,40 €	4,79 €	4,40 €	
		2	SPUU2010xxx02	5,28 €	6,81 €	9,58 €	8,81 €	
		3	SPUU2010xxx03	8,13 €	10,51 €	14,77 €	14,69 €	
	20x18	1	SPUU2018xxx01	3,89 €	4,59 €	6,22 €	5,63 €	
		2	SPUU2018xxx02	7,75 €	9,17 €	12,42 €	11,24 €	
		3	SPUU2018xxx03	11,94 €	14,15 €	19,15 €	18,74 €	

**TONDO PIENO**  
*ROUND BAR*

mm	<b>D</b> ø mm	m	Cod. Art./Item Code	€/pz	€/pz	€/pz	€/pz	pz/pcs
----	------------------	---	---------------------	------	------	------	------	--------

## ALLUMINIO ALUMINIUM

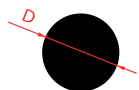

	6	1	SPTP0006xxx01	1,68 €	2,48 €	3,68 €	3,47 €	10
		2	SPTP0006xxx02	3,35 €	4,96 €	7,37 €	6,92 €	
		3	SPTP0006xxx03	5,15 €	7,65 €	11,36 €	11,51 €	
	8	1	SPTP0008xxx01	2,81 €	3,56 €	4,98 €	4,58 €	
		2	SPTP0008xxx02	5,62 €	7,14 €	9,97 €	9,15 €	
		3	SPTP0008xxx03	8,64 €	10,99 €	15,37 €	15,23 €	
	10	1	SPTP0010xxx01	4,27 €	4,95 €	6,66 €	6,01 €	
		2	SPTP0010xxx02	8,52 €	9,91 €	13,30 €	12,00 €	
		3	SPTP0010xxx03	13,13 €	15,28 €	20,53 €	20,00 €	
	12	1	SPTP0012xxx01	6,05 €	6,67 €	8,70 €	7,76 €	
		2	SPTP0012xxx02	12,08 €	13,31 €	17,39 €	15,50 €	
		3	SPTP0012xxx03	18,62 €	20,54 €	26,82 €	25,83 €	

\* Articolo a richiesta. Ordine minimo 100 pz

\* Article on request. Minimum order 100 pcs

 Completare il Cod. Art. con il tipo di finitura: es. Alluminio Naturale (**ANA**) -> SPPI0802**ANA**01  
 Complete item code with the finish type: e.g. for Natural Aluminium (**ANA**) -> SPPI0802**ANA**01

**PROFILI ALLUMINIO  
ANODIZZATO ARGENTO**  
Silver Anodized  
Aluminium Profiles

**TUBO TONDO**  
ROUND TUBE

Spessore Thickness <b>T</b>	Dimensioni Size <b>D</b>	Lunghezza Length	completa il cod. art. ( <b>xxx</b> ) con il tipo di finitura complete item code ( <b>xxx</b> ) with the finish type	Naturale <i>Natural</i>	Satinato <i>Anodized</i>	Brillante <i>Bright</i>	Verniciato Bianco White painted	Quantità per conf. Pcs. box
				( <b>ANA</b> )	( <b>AAA</b> )	( <b>ABA</b> )	( <b>AVB</b> )* **	
mm	mm	m	Cod. Art./Item Code	€/pz	€/pz	€/pz	€/pz	pz/pcs

## ALLUMINIO ALUMINIUM

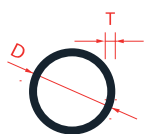

1	6	1	SPTT0601xxx01	1,02 €	1,86 €	2,94 €	2,82 €	10
		2	SPTT0601xxx02	2,05 €	3,72 €	5,89 €	5,64 €	
		3	SPTT0601xxx03	3,16 €	5,75 €	9,08 €	9,41 €	
	8	1	SPTT0801xxx01	1,34 €	2,16 €	3,31 €	3,14 €	
		2	SPTT0801xxx02	2,70 €	4,34 €	6,62 €	6,28 €	
		3	SPTT0801xxx03	4,15 €	6,69 €	10,21 €	10,46 €	
	10	1	SPTT1001xxx01	1,68 €	2,48 €	3,68 €	3,47 €	
		2	SPTT1001xxx02	3,35 €	4,96 €	7,37 €	6,92 €	
		3	SPTT1001xxx03	5,15 €	7,65 €	11,36 €	11,51 €	
	12	1	SPTT1201xxx01	1,99 €	2,79 €	4,04 €	3,77 €	
		2	SPTT1201xxx02	3,99 €	5,57 €	8,11 €	7,55 €	
		3	SPTT1201xxx03	6,15 €	8,60 €	12,50 €	12,58 €	
	16	1	SPTT1601xxx01	2,65 €	3,41 €	4,80 €	4,42 €	
		2	SPTT1601xxx02	5,29 €	6,82 €	9,60 €	8,82 €	
		3	SPTT1601xxx03	8,14 €	10,52 €	14,80 €	14,71 €	
	18	1	SPTT1801xxx01	2,97 €	3,72 €	5,17 €	4,73 €	
		2	SPTT1801xxx02	5,94 €	7,44 €	10,34 €	9,46 €	
		3	SPTT1801xxx03	9,14 €	11,47 €	15,94 €	15,77 €	
	20	1	SPTT2001xxx01	3,29 €	4,02 €	5,54 €	5,05 €	
		2	SPTT2001xxx02	6,57 €	8,05 €	11,07 €	10,09 €	
		3	SPTT2001xxx03	10,14 €	12,43 €	17,08 €	16,82 €	
	24	1	SPTT2401xxx01	3,94 €	4,65 €	6,28 €	5,69 €	
		2	SPTT2401xxx02	7,87 €	9,29 €	12,56 €	11,36 €	
		3	SPTT2401xxx03	12,13 €	14,32 €	19,37 €	18,94 €	

\* Articolo a richiesta. Ordine minimo 100 pz

\* Article on request. Minimum order 100 pcs

Completare il Cod. Art. con il tipo di finitura: es. Alluminio Naturale (**ANA**) -> SPPI0802**ANA**01Complete item code with the finish type: e.g. for Natural Aluminium (**ANA**) -> SPPI0802**ANA**01

**PROFILI ALLUMINIO  
ANODIZZATO ARGENTO**  
Silver Anodized  
Aluminium Profiles

**TUBO QUADRO**  
SQUARE TUBE

Spessore Thickness <b>T</b>	Dimensioni Size <b>WxH</b>	Lunghezza Length <b>L</b>	completa il cod. art. ( <b>xxx</b> ) con il tipo di finitura complete item code ( <b>xxx</b> ) with the finish type	Naturale <i>Natural</i>	Satinato <i>Anodized</i>	Brillante <i>Bright</i>	Verniciato Bianco White painted	Quantità per conf. Pcs. box
				( <b>ANA</b> )	( <b>AAA</b> )	( <b>ABA</b> )	( <b>AVB</b> )* **	
mm	mm	m	Cod. Art./Item Code	€/pz	€/pz	€/pz	€/pz	pz/pcs

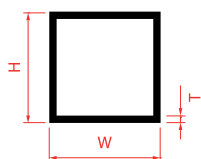
**ALLUMINIO ALUMINIUM**

1	10x10	1	SPTQ1010xxx01	2,07 €	2,86 €	4,14 €	3,85 €	10
		2	SPTQ1010xxx02	4,14 €	5,72 €	8,28 €	7,70 €	
		3	SPTQ1010xxx03	6,37 €	8,82 €	12,77 €	12,82 €	
	15x15	1	SPTQ1515xxx01	3,10 €	3,85 €	5,32 €	4,86 €	
		2	SPTQ1515xxx02	6,20 €	7,69 €	10,64 €	9,72 €	
		3	SPTQ1515xxx03	9,57 €	11,87 €	16,42 €	16,21 €	
	20x20	1	SPTQ2020xxx01	4,14 €	4,84 €	6,51 €	5,89 €	
		2	SPTQ2020xxx02	8,27 €	9,66 €	13,01 €	11,75 €	
		3	SPTQ2020xxx03	12,74 €	14,91 €	20,06 €	19,58 €	

**QUADRO PIENO**  
SQUARE BAR

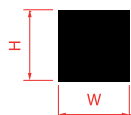
**ALLUMINIO ALUMINIUM**

1	8x8	1	SPQP0808xxx01	3,52 €	4,24 €	5,79 €	5,27 €	10
		2	SPQP0808xxx02	7,03 €	8,49 €	11,60 €	10,54 €	
		3	SPQP0808xxx03	10,83 €	13,08 €	17,88 €	17,55 €	
	10x10	1	SPQP1010xxx01	5,38 €	6,01 €	7,92 €	7,10 €	
		2	SPQP1010xxx02	10,74 €	12,03 €	15,85 €	14,18 €	
		3	SPQP1010xxx03	16,55 €	18,55 €	24,44 €	23,63 €	

**TUBO RETTANGOLARE**  
RECTANGULAR TUBE

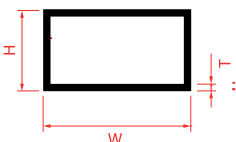
**ALLUMINIO ALUMINIUM**

1	20x10	1	SPTR2010xxx01	3,10 €	3,85 €	5,32 €	4,86 €	10
		2	SPTR2010xxx02	6,20 €	7,69 €	10,64 €	9,72 €	
		3	SPTR2010xxx03	9,57 €	11,87 €	16,42 €	16,21 €	
	30x15	1	SPTR3015xxx01	4,65 €	5,32 €	7,09 €	6,38 €	
		2	SPTR3015xxx02	9,31 €	10,66 €	14,20 €	12,77 €	
		3	SPTR3015xxx03	14,32 €	16,42 €	21,89 €	21,26 €	

\* Articolo a richiesta. Ordine minimo 100 pz

\* Article on request. Minimum order 100 pcs

Completare il Cod. Art. con il tipo di finitura: es. Alluminio Naturale (**ANA**) -> SPPI0802**ANA**01  
Complete item code with the finish type: e.g. for Natural Aluminium (**ANA**) -> SPPI0802**ANA**01



**PROFILI ALLUMINIO  
ANODIZZATO ARGENTO**  
Silver Anodized  
Aluminium Profiles

	Spessore Thickness <b>T</b>	Dimensioni Size <b>WxH</b>	Lunghezza Length	completa il cod. art. <b>(xxx)</b> con il tipo di finitura <i>complete item code (xxx) with the finish type</i>	Naturale <i>Natural</i>	Satinato <i>Anodized</i>	Brillante <i>Bright</i>	Verniciato Bianco White painted	Quantità per conf. <i>Pcs. box</i>
					<b>(ANA)</b>	<b>(AAA)</b>	<b>(ABA)</b>	<b>(AVB)* **</b>	
<b>"T" T PROFILE</b>	mm	mm	m	Cod. Art./Item Code	€/pz	€/pz	€/pz	€/pz	pz/pcs

## ALLUMINIO ALUMINIUM

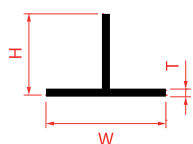

1,5	15x15	1	SPPT1515xxx01	2,46 €	3,24 €	4,58 €	4,24 €	10
		2	SPPT1515xxx02	4,93 €	6,47 €	9,16 €	8,47 €	
		3	SPPT1515xxx03	7,59 €	9,99 €	14,12 €	14,11 €	
	20x20	1	SPPT2020xxx01	3,23 €	3,97 €	5,48 €	4,98 €	
		2	SPPT2020xxx02	6,45 €	7,93 €	10,95 €	9,97 €	
		3	SPPT2020xxx03	9,95 €	12,23 €	16,89 €	16,61 €	
	25x25	1	SPPT2525xxx01	4,01 €	4,71 €	6,36 €	5,75 €	
		2	SPPT2525xxx02	8,01 €	9,42 €	12,71 €	11,50 €	
		3	SPPT2525xxx03	12,34 €	14,52 €	19,60 €	19,15 €	
	30x15	1	SPPT3015xxx01	3,62 €	4,34 €	5,91 €	5,37 €	
		2	SPPT3015xxx02	7,25 €	8,69 €	11,81 €	10,75 €	
		3	SPPT3015xxx03	11,16 €	13,40 €	18,23 €	17,90 €	

**PROFILI ALLUMINIO  
ANODIZZATO ARGENTO**  
Silver Anodized  
Aluminium Profiles

	Spessore Thickness <b>T</b>	Dimensioni Size <b>WxH</b>	Lunghezza Length	completa il cod. art. <b>(xxx)</b> con il tipo di finitura <i>complete item code (xxx) with the finish type</i>	Naturale <i>Natural</i>	Satinato <i>Anodized</i>	Brillante <i>Bright</i>	Verniciato Bianco White painted	Quantità per conf. <i>Pcs. box</i>
					<b>(ANA)</b>	<b>(AAA)</b>	<b>(ABA)</b>	<b>(AVB)* **</b>	
<b>UNGHIETTA J-PROFILE</b>	mm	mm	m	Cod. Art./Item Code	€/pz	€/pz	€/pz	€/pz	pz/pcs

## ALLUMINIO ALUMINIUM

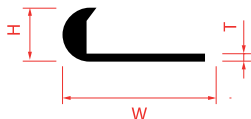

1	18x7	1	SPUN1807xxx01	1,81 €	2,61 €	3,84 €	3,60 €	10
		2	SPUN1807xxx02	3,62 €	5,22 €	7,68 €	7,18 €	
		3	SPUN1807xxx03	5,58 €	8,06 €	11,85 €	11,97 €	
	22x7	1	SPUN2207xxx01	2,02 €	2,81 €	4,08 €	3,80 €	
		2	SPUN2207xxx02	4,03 €	5,62 €	8,15 €	7,59 €	
		3	SPUN2207xxx03	6,21 €	8,67 €	12,57 €	12,64 €	

\* Articolo a richiesta. Ordine minimo 100 pz

\* Article on request. Minimum order 100 pcs

 Completare il Cod. Art. con il tipo di finitura: es. Alluminio Naturale **(ANA)** -> SPPI0802**ANA**01  
 Complete item code with the finish type: e.g. for Natural Aluminium **(ANA)** -> SPPI0802**ANA**01

PIATTO FLAT BAR	Spessore Thickness <b>T</b>	Dimensioni Size <b>W</b>	Lunghezza Length	completa il cod. art. (xxx) con il tipo di finitura complete item code (xxx) with the finish type	Nero satinato Anodized black <b>(AAN)</b>	Nero brillante Bright black <b>(ABN)**</b>	Quantità per conf. Pcs. box
	mm	mm	m	Cod. Art./Item Code	€/pz	€/pz	pz/pcs

**ALLUMINIO ALUMINIUM**



2	10	1	SPPI1002xxx01	2,81 €	4,43 €	10
		2	SPPI1002xxx02	5,61 €	8,86 €	
		3	SPPI1002xxx03	8,64 €	13,52 €	
	12	1	SPPI1202xxx01	3,08 €	4,78 €	
		2	SPPI1202xxx02	6,15 €	9,53 €	
		3	SPPI1202xxx03	9,47 €	14,55 €	
	15	1	SPPI1502xxx01	3,47 €	5,27 €	
		2	SPPI1502xxx02	6,95 €	10,52 €	
		3	SPPI1502xxx03	10,70 €	16,02 €	
	20	1	SPPI2002xxx01	4,14 €	6,08 €	
		2	SPPI2002xxx02	8,29 €	12,17 €	
		3	SPPI2002xxx03	12,76 €	18,56 €	
	25	1	SPPI2502xxx01	4,81 €	6,90 €	
		2	SPPI2502xxx02	9,63 €	13,80 €	
		3	SPPI2502xxx03	14,80 €	21,06 €	
	30	1	SPPI3002xxx01	5,48 €	7,72 €	
		2	SPPI3002xxx02	10,95 €	15,46 €	
		3	SPPI3002xxx03	16,86 €	23,57 €	
	35	1	SPPI3502xxx01	6,14 €	8,55 €	
		2	SPPI3502xxx02	12,29 €	17,09 €	
		3	SPPI3502xxx03	18,91 €	26,08 €	
	40	1	SPPI4002xxx01	6,81 €	9,37 €	
		2	SPPI4002xxx02	13,63 €	18,74 €	
		3	SPPI4002xxx03	20,97 €	28,57 €	
	50	1	SPPI5002xxx01	8,14 €	11,01 €	
		2	SPPI5002xxx02	16,29 €	22,01 €	
		3	SPPI5002xxx03	25,07 €	33,60 €	

\* Articolo a richiesta. Ordine minimo 100 pz

\* Article on request. Minimum order 100 pcs

Completare il Cod. Art. con il tipo di finitura: es. Alluminio Naturale (**ANA**) -> SPPI0802**ANA**01  
Complete item code with the finish type: e.g. for Natural Aluminium (**ANA**) -> SPPI0802**ANA**01

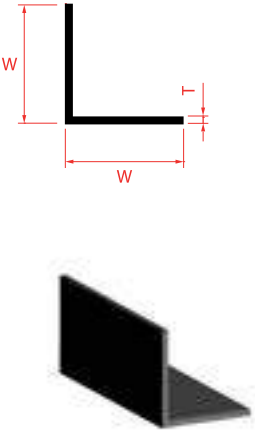

ANGOLARE EQUAL SIDED ANGLE	Spessore Thickness <b>T</b>	Dimensioni Size <b>W</b>	Lunghezza Length	completa il cod. art. (xxx) con il tipo di finitura complete item code (xxx) with the finish type	Nero satinato Anodized black (AAN)	Nero brillante Bright black (ABN)**	Quantità per conf. Pcs. box	
	mm	mm	m	Cod. Art./Item Code	€/pz	€/pz	pz/pcs	
ALLUMINIO ALUMINIUM  	1	10	1	SPAN1010xxx01	2,74 €	4,35 €	10	
			2	SPAN1010xxx02	5,48 €	8,70 €		
			3	SPAN1010xxx03	8,44 €	13,27 €		
		15	1	SPAN1515xxx01	3,41 €	5,18 €		
			2	SPAN1515xxx02	6,82 €	10,37 €		
			3	SPAN1515xxx03	10,50 €	15,82 €		
			20	1	SPAN2020xxx01	4,08 €		6,00 €
				2	SPAN2020xxx02	8,16 €		12,00 €
				3	SPAN2020xxx03	12,56 €		18,31 €
	25	1	SPAN2525xxx01	4,75 €	6,82 €			
		2	SPAN2525xxx02	9,48 €	13,64 €			
		3	SPAN2525xxx03	14,60 €	20,81 €			
	30	1	SPAN3030xxx01	5,34 €	7,56 €			
		2	SPAN3030xxx02	10,68 €	15,13 €			
		3	SPAN3030xxx03	16,45 €	23,07 €			
	1,5	40	1	SPAN4040xxx01	9,37 €	12,53 €		
			2	SPAN4040xxx02	18,74 €	25,06 €		
			3	SPAN4040xxx03	28,85 €	38,22 €		
		50	1	SPAN5050xxx01	11,38 €	15,00 €		
			2	SPAN5050xxx02	22,76 €	29,99 €		
			3	SPAN5050xxx03	35,03 €	45,75 €		

\* Articolo a richiesta. Ordine minimo 100 pz  
\* Article on request. Minimum order 100 pcs

Completare il Cod. Art. con il tipo di finitura: es. Alluminio Naturale (ANA) -> SPPI0802ANA01  
Complete item code with the finish type: e.g. for Natural Aluminium (ANA) -> SPPI0802ANA01

"L" UN-EQUAL SIDED ANGLE	Spessore Thickness <b>T</b>	Dimensioni Size <b>W</b>	Lunghezza Length	completa il cod. art. (xxx) con il tipo di finitura complete item code (xxx) with the finish type	Nero satinato Anodized black (AAN)	Nero brillante Bright black (ABN)**	Quantità per conf. Pcs. box
	mm	mm	m	Cod. Art./Item Code	€/pz	€/pz	pz/pcs

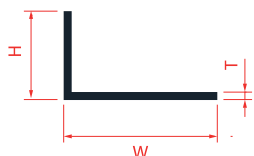
**ALLUMINIO ALUMINIUM**

1	15x10	1	SPEL1510xxx01	2,67 €	4,78 €	10
		2	SPEL1510xxx02	5,35 €	9,53 €	
		3	SPEL1510xxx03	8,02 €	14,55 €	
	20x10	1	SPEL2010xxx01	2,97 €	5,18 €	
		2	SPEL2010xxx02	5,93 €	10,35 €	
		3	SPEL2010xxx03	8,90 €	15,80 €	
	25x15	1	SPEL2515xxx01	3,55 €	6,00 €	
		2	SPEL2515xxx02	7,10 €	12,00 €	
		3	SPEL2515xxx03	10,64 €	18,31 €	
	30x15	1	SPEL3015xxx01	3,84 €	6,41 €	
		2	SPEL3015xxx02	7,68 €	12,82 €	
		3	SPEL3015xxx03	11,52 €	19,56 €	
	30x20	1	SPEL3020xxx01	4,13 €	6,82 €	
		2	SPEL3020xxx02	8,26 €	13,64 €	
		3	SPEL3020xxx03	12,39 €	20,81 €	
	40x10	1	SPEL4010xxx01	4,13 €	6,82 €	
		2	SPEL4010xxx02	8,26 €	13,64 €	
		3	SPEL4010xxx03	12,39 €	20,81 €	
	40x15	1	SPEL4015xxx01	4,41 €	7,23 €	
		2	SPEL4015xxx02	8,81 €	14,46 €	
		3	SPEL4015xxx03	13,22 €	22,05 €	

\* Articolo a richiesta. Ordine minimo 100 pz

\* Article on request. Minimum order 100 pcs

Completare il Cod. Art. con il tipo di finitura: es. Alluminio Naturale (ANA) -> SPPI0802ANA01  
Complete item code with the finish type: e.g. for Natural Aluminium (ANA) -> SPPI0802ANA01

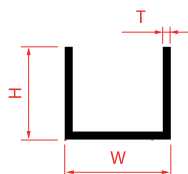

"U" U PROFILE	Spessore Thickness <b>T</b>	Dimensioni Size <b>W</b>	Lunghezza Length	completa il cod. art. (xxx) con il tipo di finitura complete item code (xxx) with the finish type	Nero satinato Anodized black (AAN)	Nero brillante Bright black (ABN)**	Quantità per conf. Pcs. box
	mm	mm	m	Cod. Art./Item Code	€/pz	€/pz	pz/pcs

**ALLUMINIO ALUMINIUM**

1	8x8	1	SPCU0808xxx01	2,95 €	4,60 €	10
		2	SPCU0808xxx02	5,88 €	9,21 €	
		3	SPCU0808xxx03	9,06 €	14,04 €	
	10x10	1	SPCU1010xxx01	3,35 €	5,10 €	
		2	SPCU1010xxx02	6,68 €	10,19 €	
		3	SPCU1010xxx03	10,29 €	15,55 €	
	10x15	1	SPCU1015xxx01	4,02 €	5,92 €	
		2	SPCU1015xxx02	8,02 €	11,84 €	
		3	SPCU1015xxx03	12,35 €	18,06 €	
	15x10	1	SPCU1510xxx01	3,68 €	5,51 €	
		2	SPCU1510xxx02	7,35 €	11,01 €	
		3	SPCU1510xxx03	11,32 €	16,80 €	
	15x15	1	SPCU1515xxx01	4,34 €	6,33 €	
		2	SPCU1515xxx02	8,69 €	12,66 €	
		3	SPCU1515xxx03	13,36 €	19,31 €	
	20x20	1	SPCU2020xxx01	5,34 €	7,56 €	
		2	SPCU2020xxx02	10,68 €	15,13 €	
		3	SPCU2020xxx03	16,45 €	23,07 €	

\* Articolo a richiesta. Ordine minimo 100 pz

\* Article on request. Minimum order 100 pcs

PIATTO FLAT BAR	Spessore Thickness <b>T</b>	Dimensioni Size <b>W</b>	Lunghezza Length <b>L</b>	completa il cod. art. (xxx) con il tipo di finitura complete item code (xxx) with the finish type	Oro satinato Anodized gold (AA0)	Oro brillante Bright gold (AB0)**	Quantità per conf. Pcs. box
	mm	mm	m	Cod. Art./Item Code	€/pz	€/pz	pz/pcs

## ALLUMINIO ALUMINIUM



2	10	1	SPPI1002xxx01	2,39 €	3,74 €	10
		2	SPPI1002xxx02	4,77 €	7,48 €	
		3	SPPI1002xxx03	7,29 €	8,38 €	
	12	1	SPPI1202xxx01	2,62 €	4,03 €	
		2	SPPI1202xxx02	5,23 €	8,04 €	
		3	SPPI1202xxx03	7,99 €	9,19 €	
	15	1	SPPI1502xxx01	2,95 €	4,44 €	
		2	SPPI1502xxx02	5,91 €	8,87 €	
		3	SPPI1502xxx03	9,02 €	10,38 €	
	20	1	SPPI2002xxx01	3,52 €	5,13 €	
		2	SPPI2002xxx02	7,05 €	10,27 €	
		3	SPPI2002xxx03	10,76 €	12,38 €	
	25	1	SPPI2502xxx01	4,09 €	5,82 €	
		2	SPPI2502xxx02	8,19 €	11,65 €	
		3	SPPI2502xxx03	12,49 €	14,36 €	
	30	1	SPPI3002xxx01	4,66 €	6,51 €	
		2	SPPI3002xxx02	9,31 €	13,04 €	
		3	SPPI3002xxx03	14,23 €	16,36 €	
	35	1	SPPI3502xxx01	5,22 €	7,22 €	
		2	SPPI3502xxx02	10,45 €	14,42 €	
		3	SPPI3502xxx03	15,95 €	18,34 €	
	40	1	SPPI4002xxx01	5,79 €	7,91 €	
		2	SPPI4002xxx02	11,59 €	15,81 €	
		3	SPPI4002xxx03	17,69 €	20,34 €	
50	1	SPPI5002xxx01	6,93 €	9,29 €		
	2	SPPI5002xxx02	13,85 €	18,57 €		
	3	SPPI5002xxx03	21,15 €	24,33 €		

\* Articolo a richiesta. Ordine minimo 100 pz

\* Article on request. Minimum order 100 pcs

 Completare il Cod. Art. con il tipo di finitura: es. Alluminio Naturale (ANA) -> SPPI0802ANA01  
 Complete item code with the finish type: e.g. for Natural Aluminium (ANA) -> SPPI0802ANA01

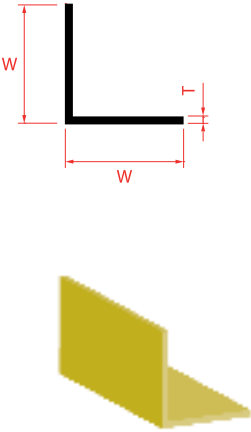

ANGOLARE EQUAL SIDED ANGLE	Spessore Thickness <b>T</b>	Dimensioni Size <b>W</b>	Lunghezza Length	completa il cod. art. (xxx) con il tipo di finitura complete item code (xxx) with the finish type	Oro satinato Anodized gold (AA0)	Oro brillante Bright gold (AB0)**	Quantità per conf. Pcs. box	
	mm	mm	m	Cod. Art./Item Code	€/pz	€/pz	pz/pcs	
ALLUMINIO ALUMINIUM  	1	10	1	SPAN1010xxx01	2,37 €	3,67 €	10	
			2	SPAN1010xxx02	4,66 €	7,34 €		
			3	SPAN1010xxx03	7,12 €	11,31 €		
		15	1	SPAN1515xxx01	2,96 €	4,37 €		
			2	SPAN1515xxx02	5,80 €	8,75 €		
			3	SPAN1515xxx03	8,87 €	13,47 €		
			20	1	SPAN2020xxx01	3,47 €		5,06 €
				2	SPAN2020xxx02	6,94 €		10,13 €
				3	SPAN2020xxx03	10,60 €		15,60 €
		25	1	SPAN2525xxx01	4,04 €	5,75 €		
			2	SPAN2525xxx02	8,06 €	11,51 €		
			3	SPAN2525xxx03	12,32 €	17,72 €		
		30	1	SPAN3030xxx01	4,54 €	6,37 €		
			2	SPAN3030xxx02	9,24 €	12,76 €		
			3	SPAN3030xxx03	13,88 €	19,65 €		
		1,5	40	1	SPAN4040xxx01	7,97 €		10,57 €
				2	SPAN4040xxx02	16,23 €		21,14 €
				3	SPAN4040xxx03	24,34 €		32,56 €
	50		1	SPAN5050xxx01	9,68 €	12,65 €		
			2	SPAN5050xxx02	19,35 €	25,31 €		
			3	SPAN5050xxx03	29,03 €	38,98 €		

\* Articolo a richiesta. Ordine minimo 100 pz

\* Article on request. Minimum order 100 pcs

Completare il Cod. Art. con il tipo di finitura: es. Alluminio Naturale (ANA) -> SPPI0802ANA01  
Complete item code with the finish type: e.g. for Natural Aluminium (ANA) -> SPPI0802ANA01

"L" UN-EQUAL SIDED ANGLE	Spessore Thickness <b>T</b>	Dimensioni Size <b>W</b>	Lunghezza Length	completa il cod. art. (xxx) con il tipo di finitura complete item code (xxx) with the finish type	Oro satinato Anodized gold (AA0)	Oro brillante Bright gold (AB0)**	Quantità per conf. Pcs. box
	mm	mm	m	Cod. Art./Item Code	€/pz	€/pz	pz/pcs

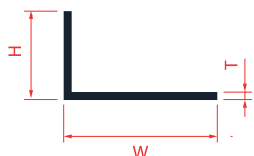
**ALLUMINIO ALUMINIUM**

1	15x10	1	SPEL1510xxx01	2,62 €	4,03 €	10
		2	SPEL1510xxx02	5,23 €	8,04 €	
		3	SPEL1510xxx03	7,99 €	12,40 €	
	20x10	1	SPEL2010xxx01	2,90 €	4,37 €	
		2	SPEL2010xxx02	5,80 €	8,73 €	
		3	SPEL2010xxx03	8,86 €	13,46 €	
	25x15	1	SPEL2515xxx01	3,47 €	5,06 €	
		2	SPEL2515xxx02	6,94 €	10,13 €	
		3	SPEL2515xxx03	10,60 €	15,60 €	
	30x15	1	SPEL3015xxx01	3,75 €	5,41 €	
		2	SPEL3015xxx02	7,51 €	10,82 €	
		3	SPEL3015xxx03	11,47 €	16,66 €	
	30x20	1	SPEL3020xxx01	4,04 €	5,75 €	
		2	SPEL3020xxx02	8,08 €	11,51 €	
		3	SPEL3020xxx03	12,34 €	17,72 €	
	40x10	1	SPEL4010xxx01	4,04 €	5,75 €	
		2	SPEL4010xxx02	8,08 €	11,51 €	
		3	SPEL4010xxx03	12,34 €	17,72 €	
	40x15	1	SPEL4015xxx01	4,31 €	6,10 €	
		2	SPEL4015xxx02	8,62 €	12,20 €	
		3	SPEL4015xxx03	13,16 €	18,79 €	

\* Articolo a richiesta. Ordine minimo 100 pz

\* Article on request. Minimum order 100 pcs

Completare il Cod. Art. con il tipo di finitura: es. Alluminio Naturale (ANA) -> SPPI0802ANA01  
Complete item code with the finish type: e.g. for Natural Aluminium (ANA) -> SPPI0802ANA01





TUBO TONDO ROUND TUBE	Spessore Thickness <b>T</b>	Dimensioni Size <b>W</b>	Lunghezza Length	completa il cod. art. (xxx) con il tipo di finitura complete item code (xxx) with the finish type	Oro satinato Anodized gold (AA0)	Oro brillante Bright gold (AB0)**	Quantità per conf. Pcs. box
	mm	mm	m	Cod. Art./Item Code	€/pz	€/pz	pz/pcs

## ALLUMINIO ALUMINIUM

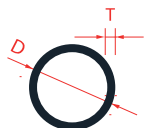

1	6	1	SPTT0601xxx01	2,14 €	3,45 €	10
		2	SPTT0601xxx02	4,28 €	6,90 €	
		3	SPTT0601xxx03	6,55 €	10,63 €	
	8	1	SPTT0801xxx01	2,49 €	3,88 €	
		2	SPTT0801xxx02	5,00 €	7,77 €	
		3	SPTT0801xxx03	7,63 €	11,96 €	
	10	1	SPTT1001xxx01	2,86 €	4,32 €	
		2	SPTT1001xxx02	5,72 €	8,64 €	
		3	SPTT1001xxx03	8,72 €	13,30 €	
	12	1	SPTT1201xxx01	3,21 €	4,75 €	
		2	SPTT1201xxx02	6,42 €	9,51 €	
		3	SPTT1201xxx03	9,81 €	14,64 €	
	16	1	SPTT1601xxx01	3,93 €	5,63 €	
		2	SPTT1601xxx02	7,85 €	11,25 €	
		3	SPTT1601xxx03	11,99 €	17,33 €	
	18	1	SPTT1801xxx01	4,28 €	6,06 €	
		2	SPTT1801xxx02	8,56 €	12,11 €	
		3	SPTT1801xxx03	13,08 €	18,66 €	
	20	1	SPTT2001xxx01	4,63 €	6,50 €	
		2	SPTT2001xxx02	9,27 €	12,98 €	
		3	SPTT2001xxx03	14,17 €	20,01 €	
	24	1	SPTT2401xxx01	5,35 €	7,37 €	
		2	SPTT2401xxx02	10,69 €	14,72 €	
		3	SPTT2401xxx03	16,34 €	22,68 €	

\* Articolo a richiesta. Ordine minimo 100 pz

\* Article on request. Minimum order 100 pcs

"U" U PROFILE	Spessore Thickness <b>T</b>	Dimensioni Size <b>W</b>	Lunghezza Length	completa il cod. art. (xxx) con il tipo di finitura complete item code (xxx) with the finish type	Oro satinato Anodized gold (AA0)	Oro brillante Bright gold (AB0)**	Quantità per conf. Pcs. box
	mm	mm	m	Cod. Art./Item Code	€/pz	€/pz	pz/pcs

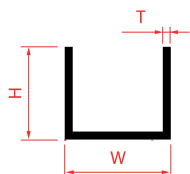
**ALLUMINIO ALUMINIUM**

1	8x8	1	SPCU0808xxx01	2,51 €	3,88 €	10
		2	SPCU0808xxx02	5,00 €	7,77 €	
		3	SPCU0808xxx03	7,64 €	11,96 €	
	10x10	1	SPCU1010xxx01	2,85 €	4,31 €	
		2	SPCU1010xxx02	5,68 €	8,60 €	
		3	SPCU1010xxx03	8,68 €	13,25 €	
	10x15	1	SPCU1015xxx01	3,42 €	5,00 €	
		2	SPCU1015xxx02	6,82 €	9,99 €	
		3	SPCU1015xxx03	10,42 €	15,39 €	
	15x10	1	SPCU1510xxx01	3,13 €	4,65 €	
		2	SPCU1510xxx02	6,25 €	9,29 €	
		3	SPCU1510xxx03	9,55 €	14,31 €	
	15x15	1	SPCU1515xxx01	3,69 €	5,34 €	
		2	SPCU1515xxx02	7,39 €	10,68 €	
		3	SPCU1515xxx03	11,27 €	16,45 €	
	20x20	1	SPCU2020xxx01	4,54 €	6,37 €	
		2	SPCU2020xxx02	9,08 €	12,76 €	
		3	SPCU2020xxx03	13,88 €	19,65 €	

\* Articolo a richiesta. Ordine minimo 100 pz

\* Article on request. Minimum order 100 pcs



SPECIAL  
PROFILES

**Profili in Acciaio per il Fai da Te**  
S-Steel Do It Yourself Profiles

**PROFILI ACCIAIO LUCIDO**  
 Polished S-Steel Profiles

**PIATTO**  
*FLAT BAR*

Spessore <i>Thickness</i> <b>T</b>	Dimensioni <i>Size</i> <b>W</b>	completa il cod. art. (xx) con il tipo di lunghezza <i>complete item code (xx)</i> <i>with the length</i>	Lunghezza <i>Length</i>		Quantità per conf. <i>Pcs. box</i>
			(1 m)	(2 m)	
mm	mm	Cod. Art./Item Code	€/pz	€/pz	pz/pcs

**ACCIAIO S-STEEL**  
**AISI 304**

0,7	10	SPPI1007ILAxx	1,98 €	3,96 €	10
	15	SPPI1507ILAxx	2,74 €	5,49 €	
	20	SPPI2007ILAxx	3,53 €	7,06 €	
	25	SPPI2507ILAxx	4,29 €	8,58 €	
	30	SPPI3007ILAxx	5,06 €	10,12 €	
	40	SPPI4007ILAxx	6,60 €	13,19 €	
	50	SPPI5007ILAxx	8,13 €	16,26 €	

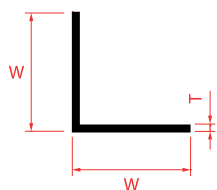
**ANGOLARE**  
*ANGLE, EQUAL SIDED*
**ACCIAIO S-STEEL**  
**AISI 304**

0,7	10	SPAN1007ILAxx	3,32 €	6,65 €	10
	15	SPAN1507ILAxx	4,39 €	8,78 €	
	20	SPAN2007ILAxx	5,44 €	10,89 €	
	30	SPAN3007ILAxx	7,56 €	15,12 €	
	40	SPAN4007ILAxx	9,68 €	19,35 €	
	50	SPAN5007ILAxx	11,79 €	23,59 €	



lunghezze superiori a 2 m disponibili solo su richiesta - lunghezza massima fornibile m 2.7.  
*lengths longer than 2 m available on request only - maximum length available 2.7 m.*

Completare il Cod. Art. con la lunghezza barra: ad es.barra da 1 metro -> SPPI1007IL01 (01 = 1m) (02 = 2m)  
*Complete item code with the bar's length: e.g. for 1 m -> SPPI1007IL01 (01 = 1m) (02 = 2m)*

**PROFILI ACCIAIO LUCIDO**  
 Polished S-Steel Profiles

**"L"**  
 UN-EQUAL SIDED ANGLE

Spessore Thickness <b>T</b>	Dimensioni Size <b>WxH</b>	completa il cod. art. (xx) con il tipo di lunghezza complete item code (xx) with the length	Lunghezza Length		Quantità per conf. Pcs. box
			(1 m)	(2 m)	
mm	mm	Cod. Art./Item Code	€/pz	€/pz	pz/pcs

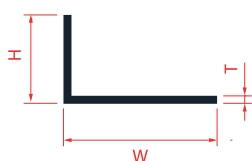
**ACCIAIO S-STEEL**  
**AISI 304**

0,7	15x10	SPEL151007ILAxx	3,85 €	7,71 €	10
	20x10	SPEL201007ILAxx	4,39 €	8,78 €	
	30x20	SPEL302007ILAxx	6,51 €	13,01 €	
	40x10	SPEL401007ILAxx	6,51 €	13,01 €	

**"U"**

## U PROFILE

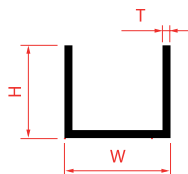
**ACCIAIO S-STEEL**  
**AISI 304**

0,7	10x10	SPCU101007ILAxx	4,67 €	9,34 €	10
	10x15	SPCU101507ILAxx	5,82 €	11,65 €	
	10x20	SPCU102007ILAxx	6,98 €	13,96 €	
	15x10	SPCU151007ILAxx	5,25 €	10,51 €	
	15x15	SPCU151507ILAxx	6,41 €	12,81 €	
	20x20	SPCU202007ILAxx	8,02 €	16,04 €	



lunghezze superiori a 2 m disponibili solo su richiesta - lunghezza massima fornibile m 2.7.  
 lengths longer than 2 m available on request only - maximum length available 2.7 m.

Completare il Cod. Art. con la lunghezza barra: ad es.barra da 1 metro -> SPPI1007IL01 (01 = 1m) (02 = 2m)  
 Complete item code with the bar's length: e.g. for 1 m -> SPPI1007IL01 (01 = 1m) (02 = 2m)



SPECIAL  
PROFILES

## **Profili in Ferro Naturale per il Fai da Te**

Do It Yourself Iron profiles



PIATTO FLAT BAR	Spessore Thickness <b>T</b>	Dimensioni Size <b>W</b>	completa il cod. art. (xx) con il tipo di lunghezza complete item code (xx) with the length	Lunghezza Length		Quantità per conf. Pcs. box
	mm	mm	Cod. Art./Item Code	(1 m)	(2 m)	
	mm	mm	Cod. Art./Item Code	€/pz	€/pz	pz/pcs

**FERRO IRON**

3	15	SPPI1503FNxx	3,12 €	6,25 €	6
	20	SPPI2003FNxx	3,34 €	6,69 €	
	25	SPPI2503FNxx	3,50 €	7,00 €	
	30	SPPI3003FNxx	4,04 €	8,09 €	
4	40	SPPI4004FNxx	6,51 €	13,01 €	
5	50	SPPI5005FNxx	9,07 €	18,14 €	

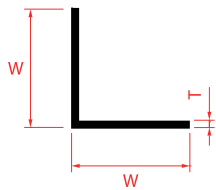
**ANGOLARE  
EQUAL SIDED ANGLE**
**FERRO IRON**

3	15	SPAN1515FNxx	5,15 €	11,33 €	6
	20	SPAN2020FNxx	5,31 €	11,68 €	
	25	SPAN2525FNxx	6,00 €	13,20 €	
	30	SPAN3030FNxx	6,27 €	14,04 €	
	40	SPAN4040FNxx	8,05 €	18,03 €	

"L" UN-EQUAL SIDED ANGLE	Spessore Thickness <b>T</b>	Dimensioni Size <b>WxH</b>	completa il cod. art. (xx) con il tipo di lunghezza complete item code (xx) with the length	Lunghezza Length		Quantità per conf. Pcs. box
	mm	mm	Cod. Art./Item Code	(1 m)	(2 m)	
	mm	mm	Cod. Art./Item Code	€/pz	€/pz	pz/pcs

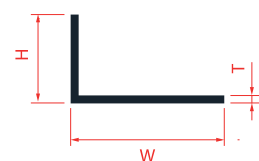
**FERRO IRON**

4	30x20	SPEL3020FNxx	10,87 €	21,74 €	6
	40x20	SPEL4020FNxx	11,45 €	22,90 €	

Completare il Cod. Art. con la lunghezza barra: ad es. barra da 1 metro -> SPPI1007IL01 (01 = 1m) (02 = 2m) (03 = 3m)  
 Complete item code with the bar's length: e.g. for 1 m -> SPPI1007IL01 (01 = 1m) (02 = 2m) (03 = 3m)

**"U"**  
U PROFILE

FERRO IRON

Spessore Thickness <b>T</b>	Dimensioni Size <b>WxH</b>	completa il cod. art. (xx) con il tipo di lunghezza complete item code (xx) with the length	Lunghezza Length		Quantità per conf. Pcs. box
			(1 m)	(2 m)	
mm	mm	Cod. Art./Item Code	€/pz	€/pz	pz/pcs

1,5	15x15	SPCU1515FNxx	3,96 €	7,92 €	6
	30x20	SPCU3020FNxx	5,34 €	10,67 €	

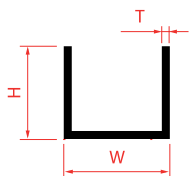

Spessore Thickness <b>T</b>	Dimensioni Size <b>D</b>	completa il cod. art. (xx) con il tipo di lunghezza complete item code (xx) with the length	Lunghezza Length		Quantità per conf. Pcs. box
			(1 m)	(2 m)	
mm	mm	Cod. Art./Item Code	€/pz	€/pz	pz/pcs

**TONDO PIENO**  
ROUND BAR

FERRO IRON

	6	SPTP0006FNxx	1,85 €	3,70 €	6
	8	SPTP0008FNxx	2,34 €	4,69 €	
	10	SPTP0010FNxx	3,34 €	6,69 €	
	12	SPTP0012FNxx	4,40 €	8,80 €	
	16	SPTP0016FNxx	7,60 €	15,21 €	

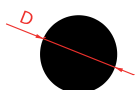

**TUBO TONDO**  
ROUND TUBE

FERRO IRON

1	12	SPTT1201FNxx	3,14 €	6,27 €	6	
	1,2	16	SPTT1601FNxx	4,37 €		8,73 €
		20	SPTT2001FNxx	5,08 €		10,16 €
1,5	25	SPTT2501FNxx	6,38 €	12,77 €		
	30	SPTT3001FNxx	7,90 €	15,79 €		
	40	SPTT4001FNxx	10,61 €	21,21 €		

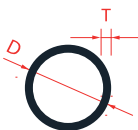

Completare il Cod. Art. con la lunghezza barra: ad es.barra da 1 metro -> SPPI1007/L01 (01 = 1m) (02 = 2m) (03 = 3m)  
Complete item code with the bar's length: e.g. for 1 m -> SPPI1007/L01 (01 = 1m) (02 = 2m) (03 = 3m)





TUBO OVALE OVAL TUBE	Spessore Thickness <b>T</b>	Dimensioni Size <b>WxH</b>	completa il cod. art. (xx) con il tipo di lunghezza complete item code (xx) with the length	Lunghezza Length		Quantità per conf. Pcs. box
				(1 m)	(2 m)	
	mm	mm	Cod. Art./Item Code	€/pz	€/pz	pz/pcs
FERRO IRON	1,5	20x10	SPTO2010FNxx	7,73 €	15,47 €	6
		30x15	SPTO3015FNxx	8,48 €	16,96 €	

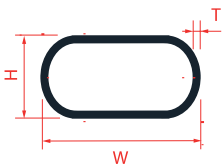

TUBO QUADRO SQUARE TUBE	FERRO IRON	1,5	12x12	SPTQ1212FNxx	6,61 €	13,22 €	6
			15x15	SPTQ1515FNxx	6,73 €	13,46 €	
			20x20	SPTQ2020FNxx	6,78 €	13,55 €	
			25x25	SPTQ2525FNxx	8,31 €	16,61 €	
			30x30	SPTQ3030FNxx	9,57 €	19,14 €	
			40x40	SPTQ4040FNxx	12,11 €	24,22 €	

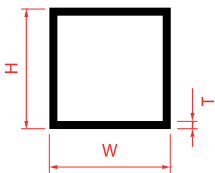

QUADRO PIENO SQUARE BAR	FERRO IRON		8x8	SPQP0808FNxx	3,31 €	6,62 €	6
			10x10	SPQP1010FNxx	4,68 €	9,35 €	
			12x12	SPQP1212FNxx	6,42 €	12,85 €	
			14x14	SPQP1414FNxx	8,50 €	17,01 €	

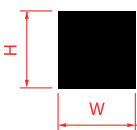

Completare il Cod. Art. con la lunghezza barra: ad es. barra da 1 metro -> SPPI1007IL01 (01 = 1m) (02 = 2m) (03 = 3m)  
 Complete item code with the bar's length: e.g. for 1 m -> SPPI1007IL01 (01 = 1m) (02 = 2m) (03 = 3m)

TUBO RETTANGOLARE RECTANGULAR TUBE	Spessore Thickness <b>T</b>	Dimensioni Size <b>WxH</b>	completa il cod. art. ( <b>xx</b> ) con il tipo di lunghezza complete item code ( <b>xx</b> ) with the length	Lunghezza Length		Quantità per conf. Pcs. box
	mm	mm	Cod. Art./Item Code	(1 m)	(2 m)	
	€/pz	€/pz				

**FERRO IRON**

1,5	30x20	SPTR3020FNxx	8,29 €	16,59 €	6
	40x20	SPTR4020FNxx	9,82 €	19,65 €	

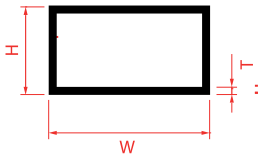

"T" T PROFILE	Spessore Thickness <b>T</b>	Dimensioni Size <b>WxH</b>	completa il cod. art. ( <b>xx</b> ) con il tipo di lunghezza complete item code ( <b>xx</b> ) with the length	Lunghezza Length		Quantità per conf. Pcs. box
FERRO IRON	mm	mm	Cod. Art./Item Code	(1 m)	(2 m)	
	€/pz	€/pz				

**"T"  
T PROFILE**

4	20x20	SPPT2020FNxx	10,25 €	20,50 €	6
	25x25	SPPT2525FNxx	13,90 €	27,81 €	
5	30x30	SPPT3030FNxx	15,11 €	30,23 €	

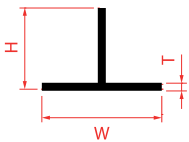

Completare il Cod. Art. con la lunghezza barra: ad es. barra da 1 metro -> SPP11007IL01 (01 = 1m) (02 = 2m) (03 = 3m)  
 Complete item code with the bar's length: e.g. for 1 m -> SPP11007IL01 (01 = 1m) (02 = 2m) (03 = 3m)

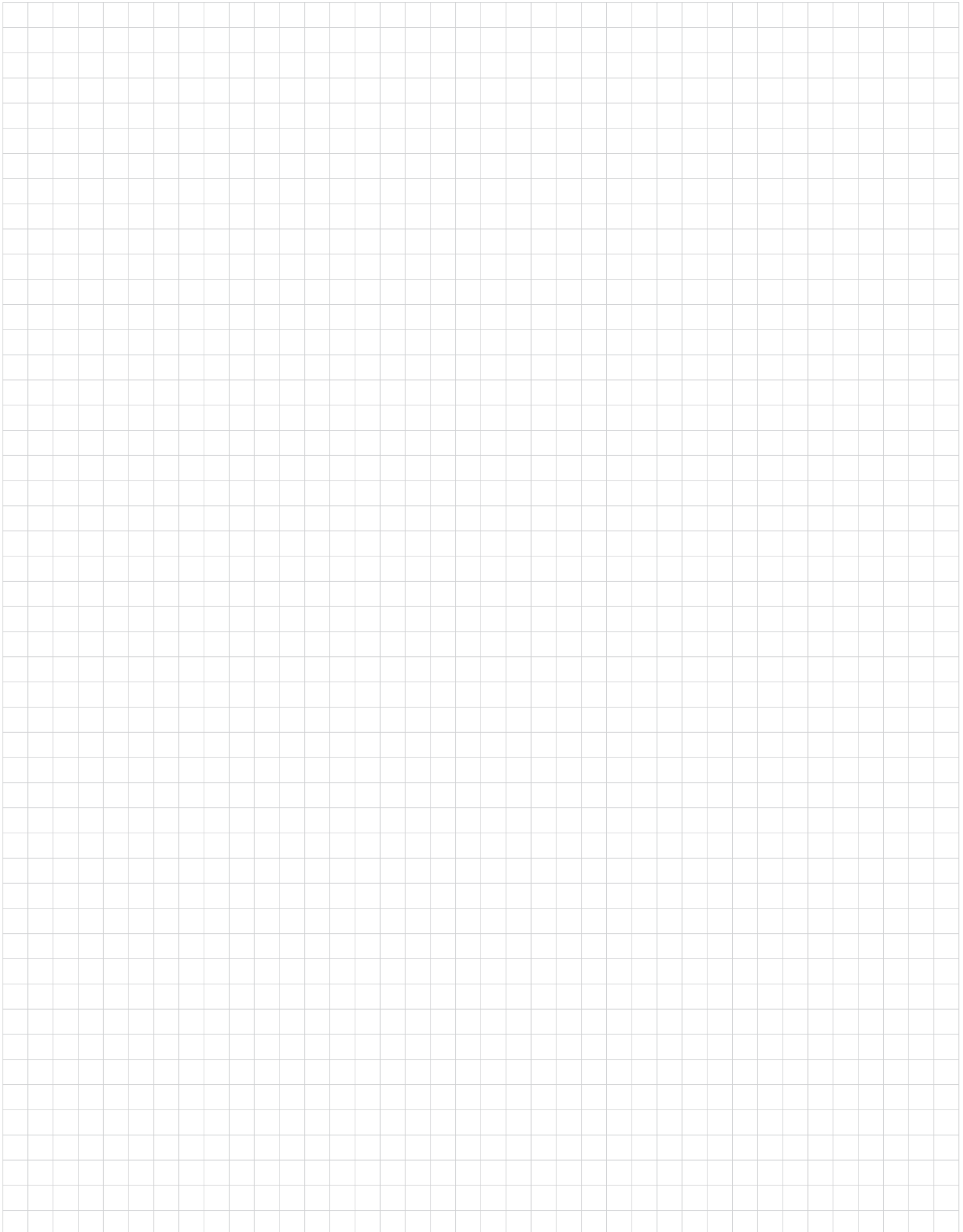



SPECIAL  
PROFILES

## **Lamiere e Profili in Alluminio, Acciaio per il Fai da te**

Aluminium, Iron, S-Steel sheets and Profiles for Do It Yourself



ANGOLARE EQUAL SIDE ANGLE	Spessore Thickness <b>T</b>	Dimensioni Size <b>WxH</b>	completa il cod. art. (xx) con il tipo di lunghezza complete item code (xx) with the length	Lunghezza Length		Quantità per conf. Pcs. box
	mm	mm	Cod. Art./Item Code	(1 m) €/pz	(2 m) €/pz	pz/pcs

**ALLUMINIO ALUMINIUM**

1,5	20x20	SPAN2020ANCxx	10,39 €	17,44 €	10
	25x25	SPAN2525ANCxx	11,81 €	20,69 €	
	30x30	SPAN3030ANCxx	13,25 €	23,97 €	
	40x40	SPAN4040ANCxx	16,09 €	30,46 €	

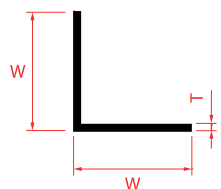

"L" UN-EQUAL SIDED ANGLE	1,5	40x20	SPEL4020ANCxx	13,25 €	23,97 €	10
		50x30	SPEL5030ANCxx	16,09 €	30,48 €	

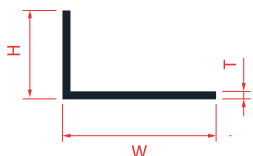
**ALLUMINIO ALUMINIUM**

"U" U PROFILE	1,5	22,5x22,5	SPCU2222ANCxx	14,31 €	26,36 €	10
		25,5x25,5	SPCU2525ANCxx	15,58 €	29,43 €	

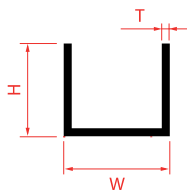
**ALLUMINIO ALUMINIUM**

lunghezze superiori a 2 m disponibili solo su richiesta - lunghezza massima fornibile m 2.7.  
lengths longer than 2 m available on request only - maximum length available 2.7 m.

Completare il Cod. Art. con la lunghezza barra: ad es.barra da 1 metro -> SPPI1007IL01 (01 = 1m) (02 = 2m)  
Complete item code with the bar's length: e.g. for 1 m -> SPPI1007IL01 (01 = 1m) (02 = 2m)



## Lamiere Alluminio, Acciaio, Ferro per il Fai da te

Aluminium, Iron, S-Steel sheets for Do It Yourself

LAMIERE METAL SHEET	Spessore Thickness T	Dimensioni Size W	Dimensioni Size H			Quantità per conf. Pcs. box-S
	mm	mm	mm	Cod. Art./Item Code	€/pz	pz/pcs
ALLUMINIO LISCIO NATURALE SILVER NATURAL PLAIN ALUMINIUM	0,7	500	200	SPLA5020AN07	6,18 €	10
	0,7		400	SPLA5040AN07	10,39 €	
	0,7		500	SPLA5050AN07	12,50 €	
	0,7		600	SPLA5060AN07	14,59 €	
	0,7		1000	SPLA5010AN07	23,01 €	

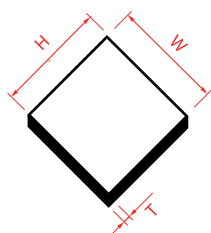

LAMIERE METAL SHEET	0,7	500	200	SPLA5020AAA07	6,76 €	10
	0,7		400	SPLA5040AAA07	11,53 €	
ALLUMINIO LISCIO ANODIZZATO SATINATO SILVER ANODIZED ALUMINIUM	0,7	500	500	SPLA5050AAA07	13,94 €	10
	0,7		600	SPLA5060AAA07	16,33 €	
	0,7		1000	SPLA5010AAA07	25,88 €	

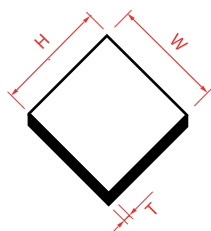

LAMIERE SHEET METAL	0,7	500	200	SPLA5020ABA07	7,67 €	10
	0,7		400	SPLA5040ABA07	13,35 €	
ALLUMINIO LISCIO BRILLANTE SILVER POLISHED PLAIN ALUMINIUM SHEET	0,7	500	500	SPLA5050ABA07	16,20 €	10
	0,7		600	SPLA5060ABA07	19,05 €	
	0,7		1000	SPLA5010ABA07	30,42 €	

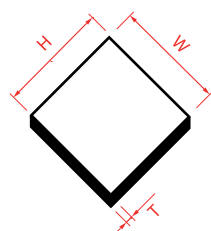

LAMIERE METAL SHEET	Spessore Thickness T	Dimensioni Size W	Dimensioni Size H			Quantità per conf. Pcs. box
	mm	mm	mm	Cod. Art./Item Code	€/pz	pz/pcs

**ALLUMINIO CHICCO DI  
RISO NATURALE**  
*CHECKERED-PLATE NATURAL  
ALUMINIUM SHEET*

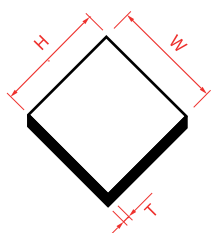

1,5	500	200	SPLC5020ANC02	17,05 €	10
		500	SPLC5050ANC02	38,40 €	
		600	SPLC5060ANC02	45,52 €	
	600	200	SPLC6020ANC02	19,90 €	
		600	SPLC6060ANC02	54,07 €	
		1000	SPLC6010ANC02	88,23 €	
	1250	1000	SPLC6010ANC02	172,93 €	
	1250	2000	SPLC6010ANC02	357,70 €	
	1000	2000	SPLC6010ANC02	286,64 €	
	1250	2500	SPLC6010ANC02	357,70 €	



LAMIERE METAL SHEET	0,7	500	200	SPLA5020IL07	12,62 €	10
	0,7		400	SPLA5040IL07	24,22 €	
	0,7		500	SPLA5050IL07	30,03 €	
	0,7		600	SPLA5060IL07	35,83 €	
	0,7		1000	SPLA5010IL07	59,06 €	

**ACCIAIO LISCIO  
BRILLANTE**  
*POLISHED PLAIN  
STEEL SHEET*

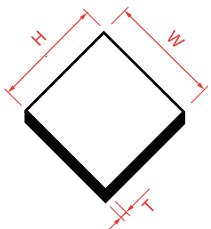



AC



**SPECIAL  
PROFILES**

## Lamiere Alluminio, Acciaio, Ferro per il Fai da te

Aluminium, Iron, S-Steel sheets for Do It Yourself

**LAMIERE STIRATE  
STRETCHED SHEETS**

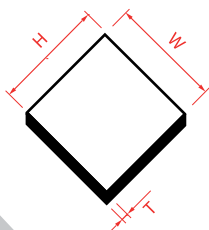
Spessore Thickness <b>T</b>	Dimensioni Size <b>W</b>	Dimensioni Size <b>H</b>		Acciaio S-Steel	Quantità per conf. Pcs. box
mm	mm	mm	Cod. Art./Item Code	€/pz	pz/pcs

**ACCIAIO AISI 304 - STEEL AISI 304**

0,8	400	500	SPLS4050IL08	15,44 €	10
		1000	SPLS4010IL08	27,10 €	
	600	500	SPLS6050IL08	16,90 €	
		1000	SPLS6010IL08	21,28 €	



AL

**LAMIERE STIRATE  
STRETCHED SHEETS**

Spessore Thickness <b>T</b>	Dimensioni Size <b>W</b>	Dimensioni Size <b>H</b>		Alluminio Aluminium	Quantità per conf. Pcs. box
mm	mm	mm	Cod. Art./Item Code	€/pz	pz/pcs

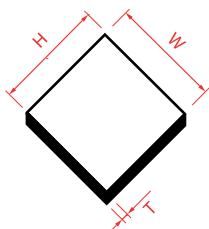
**ALLUMINIO NATURALE - NATURAL ALUMINIUM**

0,8	400	500	SPLS4050AN08	10,74 €	10
		1000	SPLS4010AN08	17,70 €	
	600	500	SPLS6050AN08	11,61 €	
		1000	SPLS6010AN08	14,21 €	



FE

**LAMIERE STIRATE  
STRETCHED SHEETS**

Spessore Thickness <b>T</b>	Dimensioni Size <b>W</b>	Dimensioni Size <b>H</b>		Ferro Iron	Quantità per conf. Pcs. box
mm	mm	mm	Cod. Art./Item Code	€/pz	pz/pcs

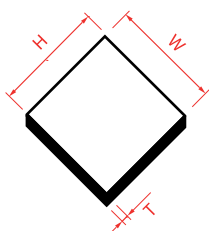
**FERRO ZINCATO - GALVANIZED IRON**

0,8	400	500	SPLS4050FZ08	9,65 €	10
		1000	SPLS4010FZ08	15,52 €	
	600	500	SPLS6050FZ08	10,39 €	
		1000	SPLS6010FZ08	12,59 €	

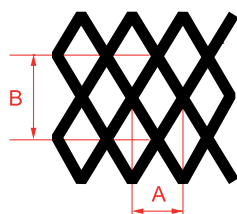
 Ax B 6x10 Alluminio/Aluminium  
 Ax B 8x16 Acciaio/Steel



SPECIAL  
PROFILES

## **Sistemi espositivi e proposte di Vendita**

Display systems and sales proposals



## Special Profiles

Tutti gli espositori Special Profiles sono studiati per offrire la massima visibilità dei prodotti e nel contempo ridurre al minimo gli ingombri. Anche la funzionalità è quanto di meglio si possa trovare sul mercato, per la semplicità con cui i vari profili si possono estrarre e reinserire. Spazi predefiniti e guidati, sia meccanicamente che tramite icone, permettono di avere tutti gli espositori facilmente e sempre in ordine. Abbondanti esempi di utilizzo facilitano la perfetta comprensione del contenuto. Tutti gli espositori sono modulari, potendo creare in maniera flessibile la propria esposizione, in funzione delle varie esigenze e disponibilità di spazio.

Infine grazie al loro design è possibile collocarli anche in ambienti spiccatamente eleganti, come una show room, impreziosendo l'ambiente.

## Special Profiles

All Special Profiles displays are designed to offer maximum product visibility and at the same time reduce the overall dimensions. Functionality is also the best you can find on the market, for the simplicity with which the various profiles can be extracted and reinserted. Predefined and guided spaces, both mechanically and through icons, allow all displays to be easily and always in order. Many examples of use facilitate the perfect understanding of the content. All display units are modular, being able to flexibly create their own area, according to the various needs and space availability.

Finally, thanks to their design, they can also be placed in distinctly elegant environments, such as a show room, enhancing the environment.

FAI DA TE / DIY

**BIG 2**

**BIG 3**

PROFIL/PROFILES

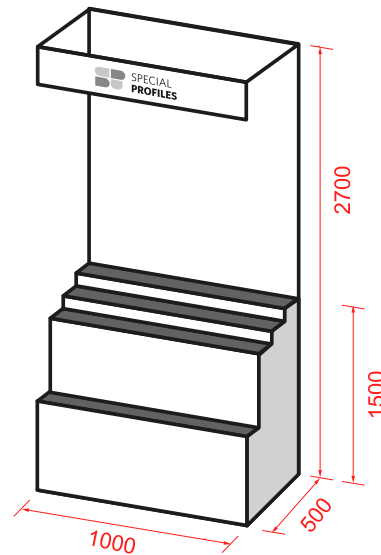
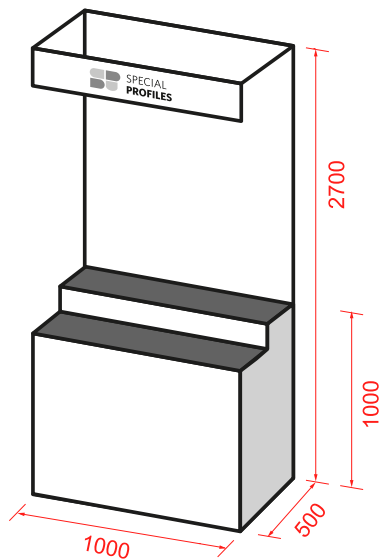

CERAMICA, EDILIZIA / TILES, BUILDING SYSTEMS





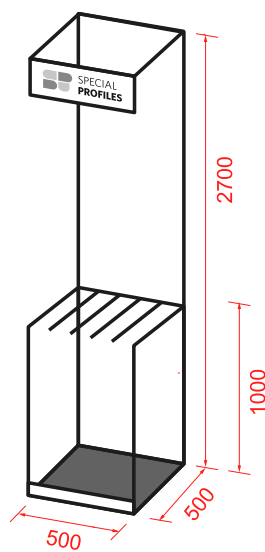
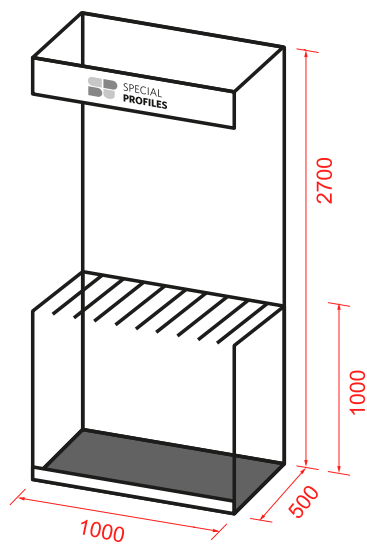

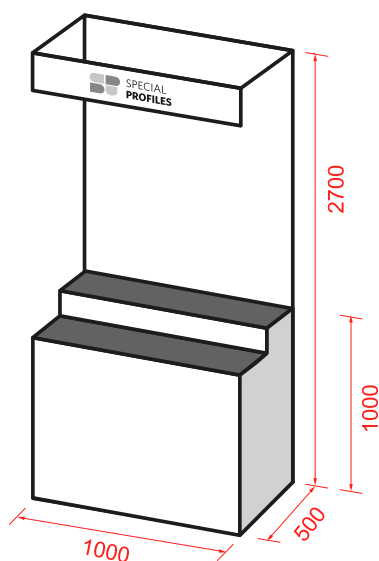
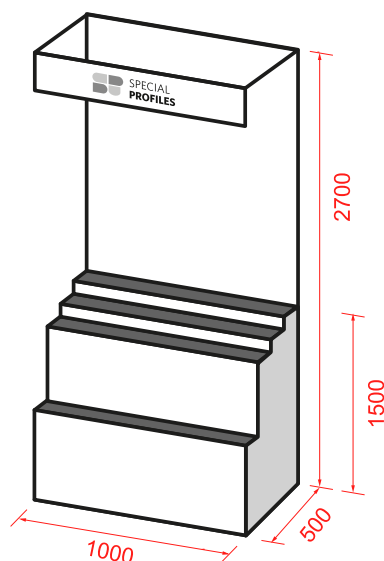



**BIG TILE**

**SMALL TILE**



**PROPOSTA FAI DA TE ALLUMINIO ALUMINIUM DIY PROPOSALS**
**BIG 2**

**BIG 3**

	pz / tipo pcs / type	Tot. referenze Total of references	Tot. barre Total of Lengths	Codice proposta Barre 2 mt Proposal code 2 m Lengths	Prezzo Price €	Codice proposta Barre 1 mt Proposal code 1 m Lengths	Prezzo Price €
Alluminio naturale Natural aluminium	20	29	580	SPANAA2G	3.780 €	SPANAA1G	1.890 €
Alluminio anodizzato argento Silver anodized aluminium	20	29	580	SPAAA2G	4.635 €	SPAAA1G	2.318 €
Alluminio brillante Silver bright anodized aluminium	20	29	580	SPABA2G	6.380 €	SPABA1G	3.190 €

									
10x2 20x2 30x2 40x2 50x2	10x10 20x20 30x30 40x40 50x50	20x10 30x15 40x10	8x8 10x10 15x15 20x20	20x18	10x1 12x1 16x1 20x1 24x1	20x10 30x15	20x20	10x10	20x20 30x15
5	5	3	4	1	5	2	1	1	2

PROPOSTA FAI DA TE ACCIAIO *S-STEEL DIY PROPOSALS*

**BIG 2**

**BIG 3**

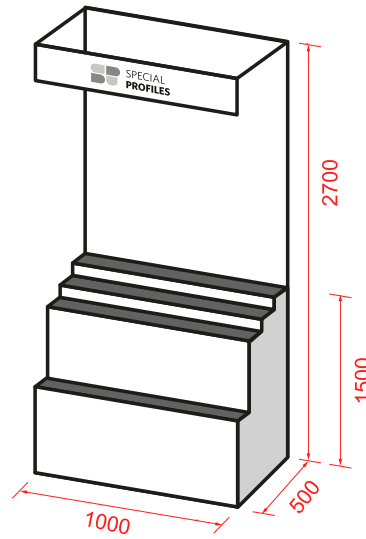
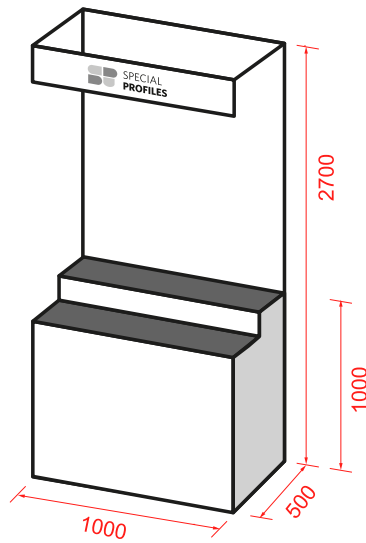





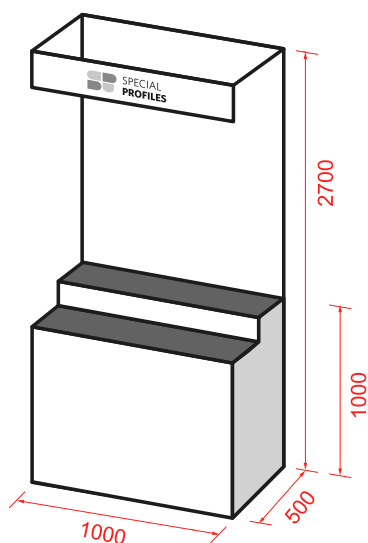
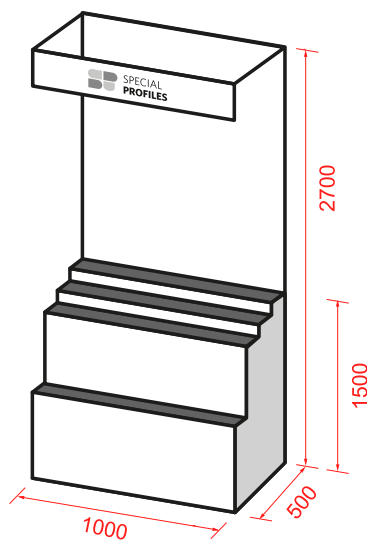





	pz / tipo pcs / type	Tot. referenze Total of references	Tot. barre Total of Lengths	Codice proposta Barre 2 mt Proposal code 2 m Lengths	Prezzo Price €	Codice proposta Barre 1 mt Proposal code 1 m Lengths	Prezzo Price €
Acciaio Steel	20	16	320	SPIL2G	4.030 €	SPIL1G	2.008 €

10x0,7 20x0,7 30x0,7 40x0,7 50x0,7	10x10x0,7 20x20x0,7 30x30x0,7 40x40x0,7 50x50x0,7	20x10x0,7 30x20x0,7 40x10x0,7	10x15x0,7 15x15x0,7 20x20x0,7
5	5	3	3

PROPOSTA FAI DA TE FERRO *IRON DIY PROPOSALS*
**BIG 2**

**BIG 3**



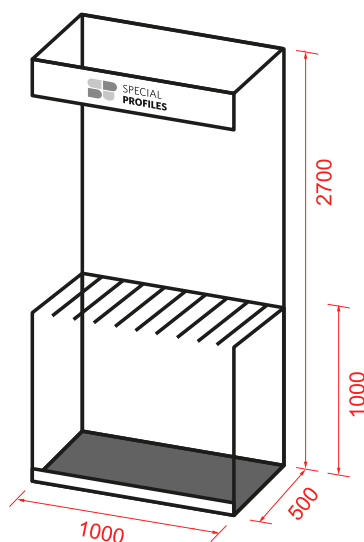







	pz / tipo pcs / type	Tot. referenze Total of references	Tot. barre Total of Lengths	Codice proposta Barre 2 mt Proposal code 2 m Lengths	Prezzo Price €	Codice proposta Barre 1 mt Proposal code 1 m Lengths	Prezzo Price €
<b>Ferro Iron</b>	12	24	288	SPFE2G	3.913 €	SPFE1G	1.957 €





									
20x3 30x3 40x4 50x5	20x20x3 30x30x3 40x40x3	30x20x4 40x20x4	15x15x1,5 30x20x1,5	10 12	16x1,2 20x1,2 25x1,2 30x1,5	30x20x1,5 40x20x1,5	20x20x1,5 30x30x1,5	8x8 12x12	25x25x4
4	3	2	2	2	4	2	2	2	1

**PROPOSTA CERAMICA, EDILIZIA**  
*TILE, BUILDINGS SYSTEMS PROPOSALS*
**BIG TILE**

Rivestimenti Mix <i>Mix Coverings</i>	pz / tipo <i>pcs / type</i>	Tot. referenze <i>Total of references</i>	Tot. prodotti <i>Total of Lengths</i>	Lunghezza Barre <i>Bar's Length</i> <b>m</b>	Codice proposta <i>Proposal code</i>	Prezzo <i>Price</i> <b>€</b>
--	--------------------------------	--	--	--	---	------------------------------------

Rivestimenti Mix <i>Mix Coverings</i>	20	25	500	mix	SPRIV2B	7.596 €
--	----	----	-----	-----	---------	---------

PVC bianco <i>PVC white</i>	PVC bianco <i>PVC white</i>	Alluminio <i>Aluminium</i>	Alluminio <i>Aluminium</i>	Acciaio <i>S-Steel</i>	Acciaio <i>S-Steel</i>	Alluminio <i>Aluminium</i>	Alluminio <i>Aluminium</i>	Acciaio <i>S-Steel</i>	Acciaio <i>S-Steel</i>
									
10 12	10 12	10 12	10 12	10 12	10 12	10 12	10 12	10 12	10 12
2	2	2	2	2	2	2	2	2	2





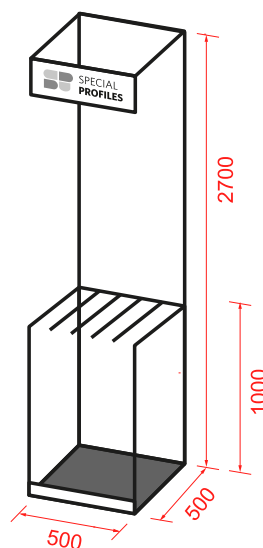





PVC bianco <i>PVC white</i>	PVC marrone <i>Brown PVC</i>	Alluminio <i>Aluminium</i>	Acciaio <i>S-Steel</i>	Acciaio <i>S-Steel</i>
				
22x22	28x28	25x25	30x30	30x30
1	1	1	1	1







**PROPOSTA CERAMICA, EDILIZIA**  
*TILE, BUILDINGS SYSTEMS PROPOSALS*
**SMALL TILE**

	pz / tipo pcs / type	Tot. referenze Total of references	Tot. prodotti Total of Lengths	Lunghezza Barre Bar's Length <b>m</b>	Codice proposta Proposal code	Prezzo Price <b>€</b>
--	-------------------------	---------------------------------------	-----------------------------------	---	----------------------------------	-----------------------------

<b>Rivestimenti Mix</b> <i>Mix Coverings</i>	<b>20</b>	<b>15</b>	<b>300</b>	<b>mix</b>	<b>SPRIV2S</b>	<b>4.904 €</b>
---	-----------	-----------	------------	------------	----------------	----------------



PVC bianco PVC white	PVC bianco PVC white	Alluminio Aluminium	Alluminio Aluminium	Acciaio S-Steel	Acciaio S-Steel	Alluminio Aluminium	Alluminio Aluminium	Acciaio S-Steel	Acciaio S-Steel
									
<b>10</b>	<b>10</b>	<b>10</b>	<b>10</b>	<b>10</b>	<b>10</b>	<b>10</b>	<b>10</b>	<b>10</b>	<b>10</b>
<b>1</b>	<b>1</b>	<b>1</b>	<b>1</b>	<b>1</b>	<b>1</b>	<b>1</b>	<b>1</b>	<b>1</b>	<b>1</b>

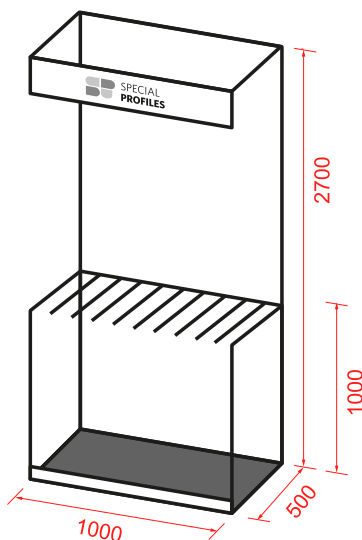





PVC bianco PVC white	PVC marrone Brown PVC	Alluminio Aluminium	Acciaio S-Steel	Acciaio S-Steel
				
<b>22x22</b>	<b>28x28</b>	<b>25x25</b>	<b>30x30</b>	<b>30x30</b>
<b>1</b>	<b>1</b>	<b>1</b>	<b>1</b>	<b>1</b>

**PROPOSTA CERAMICA, EDILIZIA**  
*TILE, BUILDING SYSTEMS PROPOSALS*
**BIG TILE**









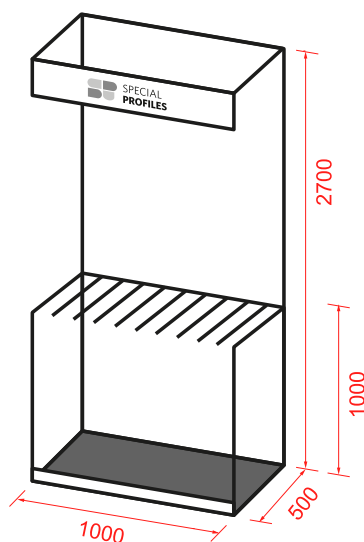







	pz / tipo pcs / type	Tot. referenze Total of references	Tot. prodotti Total of Lengths	Lunghezza Barre Bar's Length m	Codice proposta Proposal code	Prezzo Price €
--	-------------------------	--	--------------------------------------	--------------------------------------	----------------------------------	----------------------

<b>Rivestimenti PVC</b> <i>PVC Coverings</i>	<b>30</b>	<b>19</b>	<b>570</b>	<b>mix</b>	<b>SPJJ2B</b>	<b>1.949 €</b>
---	-----------	-----------	------------	------------	---------------	----------------

bianco white	avorio ivory	rosa pink	grigio grey	celeste light blue	rosa marmor. marbled pink	rosa pesca peach pink	beige chiaro light beige	beige sabbia sand beige	beige tabacco tobacco beige
									
6-8-10-12	10	10	10	10	10	10	10	10	10
4	1	1	1	1	1	1	1	1	2

travertino grigio travertine grey	crema yellow cream	travertino beige travertine beige	travertino beige travertine beige	verde brasil brazil green	grigio grey
					
10	10	10	10	10	10
1	1	1	1	1	1





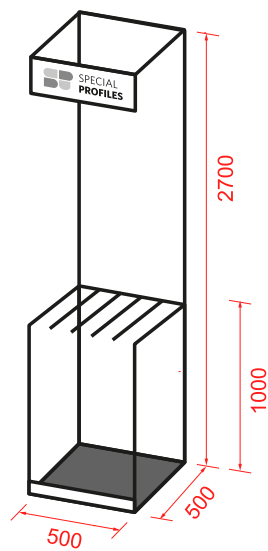



**PROPOSTE PAVIMENTO ALLUMINIO, ACCIAIO**  
*ALUMINIUM, S-STEEL FLOOR PROPOSALS*
**BIG TILE**







	pz / tipo pcs / type	Tot. referenze Total of references	Tot. prodotti Total of Lengths	Lunghezza Barre Bar's Length m	Codice proposta Proposal code	Prezzo Price €	
<b>Pavimento Floor</b>	<b>20</b>	<b>27</b>	<b>540</b>	<b>mix</b>	<b>SPFL2B</b>	<b>9.248 €</b>	
alluminio argento silver aluminium	alluminio argento silver aluminium	alluminio argento silver aluminium	all. argento + brillante bright + silver al.	all. argento + brillante bright + silver al.	acciaio s-steel	arg. + brillante bright + silver al.	all. nat. + arg. + brillante natural + bright + silver al.
							
42x26	12,5	12,5	30	25	25	20x9	5x25
1	1	1	2	2	1	2	3
all. argento + brillante bright + silver al.	acciaio s-steel	alluminio argento silver aluminium	acciaio s-steel	all. argento + brillante bright + silver al.	acciaio s-steel	acciaio s-steel	
							
8-10-12,5	10-12,5	10	10	12,5	12,5	10	
6	2	1	1	2	1	1	

**PROPOSTE PAVIMENTO ALLUMINIO, ACCIAIO**  
*ALUMINIUM, S-STEEL FLOOR PROPOSALS*
**SMALL TILE**

	pz / tipo pcs / type	Tot. referenze Total of references	Tot. prodotti Total of Lengths	Lunghezza Barre Bar's Length m	Codice proposta Proposal code	Prezzo Price €
--	-------------------------	--	--------------------------------------	--------------------------------------	----------------------------------	----------------------

<b>Pavimento Floor</b>	<b>20</b>	<b>17</b>	<b>340</b>	<b>mix</b>	<b>SPFL2S</b>	<b>6.423 €</b>
----------------------------	-----------	-----------	------------	------------	---------------	----------------

alluminio argento silver aluminium	alluminio argento silver aluminium	alluminio argento silver aluminium	all. argento silver al.	all. argento silver al.	acciaio s-steel	all. argento silver al.	all. argento silver al.
							
42x26	12,5	12,5	30	25	25	20x9	5x25
1	1	1	1	1	1	1	1

all. argento silver al.	acciaio s-steel	alluminio argento silver aluminium	acciaio s-steel	all. argento silver al.	acciaio s-steel	acciaio s-steel	
							
10-12,5	10-12,5	10	10	12,5	12,5	10	
2	2	1	1	1	1	1	

Alluminio  
Aluminium



Ferro  
Iron



Profili per Ceramica  
Tile profiles



Profili portaetichette  
Label holder profiles



Descrizione etichetta  
Label description

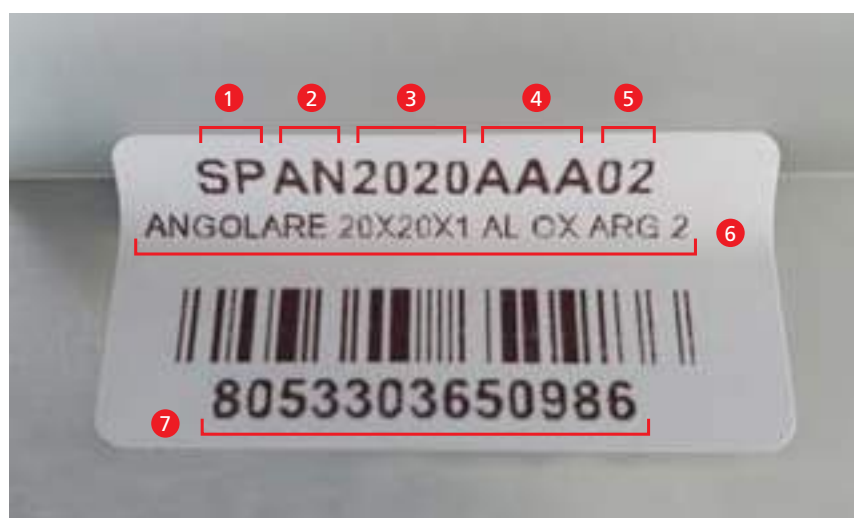

- 1- Codice azienda - *Company code*
- 2- Tipo prodotto - *Item type*
- 3- Misura prodotto - *Item size*
- 4- Finitura - *Finish*
- 5- Lunghezza profilo - *Item length*
- 6- Descrizione prodotto - *Item description*
- 7- Barcode EAN13 - *EAN13 code*

## Principali caratteristiche delle materie prime utilizzate da Special Profiles

### ALLUMINIO

Lega di alluminio ( Al-Mg-Si )

I profili sono realizzati per estrusione oppure laminazione e successiva pressopiegatura.

Presentano ottima resistenza ai principali agenti chimici ed atmosferici.

Trattamenti superficiali tramite impianti di proprietà dell'azienda, trasformano il materiale in :

- Alluminio anodizzato: ossidazione anodica con 8-10 micron di spessore dell'ossido.
- Alluminio Brillantato: ossidazione anodica con 8-10 micron di spessore dell'ossido.
- Alluminio Verniciato: a polveri, con circa 100 micron di spessore della verniciatura.

Non consigliati per utilizzo a pavimento.

### ACCIAIO INOX - AISI 304

I profili sono realizzati per laminazione e successiva pressopiegatura.

Presentano ottima resistenza ai principali agenti chimici ed atmosferici e ottima resistenza meccanica

Trattamenti superficiali tramite impianti proprietari dell'azienda, trasformano il materiale in :

Acciaio Lucido e Brillante.

Utilizzo sia a parete che a pavimento, in ambiente ospedaliero, alimentare, etc.

- Attenzione: i bordi di taglio non sono inossidabili

### PVC Rigido (Paraspigoli)

Cloruro di vinile rigido esente da piombo, antiurto, autoestingente.

Buona resistenza meccanica e all'abrasione.

### PVC Co-estruso - Rigido/Morbido (Giunti di dilatazione)

Cloruro di vinile rigido coestruso con PVC morbido esente da piombo, antiurto, autoestingente.

Ottima resistenza meccanica, all'abrasione.

### PE-HD (Distanziatori per mattonelle)

Polietilene ad alta densità, resina termoplastica, ottima stabilità chimica e resistenza meccanica. L'alta densità(HD) aumenta la sua rigidità.

### POLIPROPILENE (Angoli esterni quadrati e tondi)

Polimero termoplastico, semicristallino, con buona resistenza meccanica e all'abrasione.

### Manutenzione

Evitare il contatto diretto con cemento e suoi derivati, se umidi, prodotti decalcificanti e detergenti che contengono cloro.

Evitare l'uso di prodotti abrasivi che possano graffiare (spugne abrasive/pagliette metalliche).

Subito dopo la posa procedere con una accurata pulizia delle superfici con abbondante acqua/prodotti a PH neutro/ non alcalini, in particolare rimuovere cemento, colla dalle superfici in vista.

### Misure e tolleranze

Tutte le informazioni ed i disegni contenuti nel presente catalogo hanno carattere non impegnativo e soggette a variazione, senza preavviso.

Tutti i dati dimensionali fanno riferimento a quote nominali, soggette a tolleranze meccaniche, secondo la norma En-22768 ISO-2768 -m.

**Main characteristics of the raw materials used  
by Special Profiles****ALUMINUM**

Aluminum alloy (Al-Mg-Si)

The profiles are made by extrusion or lamination and subsequent press bending.

They have excellent resistance to the main chemical and atmospheric agents.

Surface treatments through the company's proprietary systems, transform the material into:

Anodized aluminum: anodic oxidation with 8-10 microns of oxide thickness.

Polished Aluminum: anodic oxidation with 8-10 microns of oxide thickness.

Painted Aluminum: powder coated, with about 100 microns of paint thickness.

Not recommended for floor use.

**STAINLESS S-STEEL - AISI 304**

The profiles are made by rolling and subsequent press bending.

They have excellent resistance to the main chemical and atmospheric agents and excellent mechanical resistance

Surface treatments through the company's systems, transform the material into:

Polished and bright s-steel.

Use both on the wall and on the floor; in hospitals, food, industry.

- Attention: the cutting edges are not stainless

**Rigid PVC** (Corner protectors)

Lead-free, impact-resistant, self-extinguishing rigid vinyl chloride.

Good mechanical and abrasion resistance.

**Co-extruded PVC** - Rigid / Soft (expansion joints)

Co-extruded rigid vinyl chloride with soft PVC, lead-free, shockproof, self-extinguishing.

Excellent mechanical resistance, to abrasion.

**PE-HD** (Tile spacers)

High density polyethylene, thermoplastic resin, excellent chemical stability and mechanical resistance. The high density (HD) increases its stiffness.

**POLYPROPYLENE** (External square and round corners)

Thermoplastic polymer; semi-crystalline, with good mechanical and abrasion resistance.

**Maintenance**

Avoid direct contact with concrete and its derivatives, if wet, descaling products and detergents that contain chlorine.

Avoid using abrasive products that can scratch (abrasive sponges / metal wool).

Immediately after laying proceed with a thorough cleaning of the surfaces with plenty of water / neutral / non-alkaline PH products, in particular remove cement, glue from the exposed surfaces.

**Measures and tolerances**

All information and drawings contained in this catalog are non-binding and subject to change without notice. All dimensional data refer to nominal dimensions, subject to mechanical tolerances, according to the En-22768 ISO-2768 -m standard.

# Condizioni generali di vendita

## General conditions of sale

### Sezione 1 - Condizioni Generali

- (1) I seguenti termini e condizioni generali di contratto si applicano per tutti i beni e servizi forniti a una specifica commessa, una persona giuridica di diritto pubblico o di un fondo speciale di diritto pubblico.
- (2) Se un cliente ha termini e condizioni di vendita diverse dalle nostre, e queste ultime non sono state esplicitamente loro riconosciute, le stesse sono da ritenersi non vincolanti per Mecc.AI, anche se non esplicitamente respinte.
- (3) L'acquisizione e l'interpretazione di questi termini e condizioni di vendita generali devono essere esclusivamente disciplinati dalla legge Italiana, così come la conclusione e l'interpretazione dei negozi giuridici con il cliente. L'applicazione della legge delle Nazioni Unite sulle vendite (CISG) è espressamente rifiutata.
- (4) La nullità di singole disposizioni o elementi di questi termini e condizioni di vendita generali non pregiudica la validità delle restanti disposizioni.
- (5) Il luogo di adempimento per gli obblighi creati direttamente o indirettamente dal rapporto contrattuale, compreso l'obbligo di rendere il pagamento, sarà la nostra sede aziendale.
- (6) L'esclusivo foro competente è quello in cui si trova la nostra sede aziendale.

### Sezione 2 - Quotazioni, ambito di prestazione e stipula del contratto

- (1) Le nostre quotazioni generate e pertinenti ad uno specifico contratto sono soggette a possibili modifiche senza preavviso. Gli ordini sono per noi vincolanti solo nella misura in cui vengono confermati. Qualsiasi tipo di diverso accordo verbale è da ritenersi valido soltanto se confermato per iscritto.
- (2) La nostra conferma d'ordine ha il solo valore di definire la tipologia delle prestazioni contrattualmente dovute.
- (3) Ci riserviamo il diritto di modificare il progetto, la scelta dei materiali, le specifiche dello stesso ed il metodo di costruzione, anche dopo l'invio al cliente della conferma d'ordine, a condizione che tali modifiche non siano in contraddizione né con la conferma d'ordine né con le specifiche del cliente.
- (4) I documenti su cui la quotazione o la conferma d'ordine si basano, quali diagrammi e disegni, dimensioni e dichiarazioni di peso sono, di regola, solo approssimazioni e pertanto non sono vincolanti, purché non espressamente dichiarato per iscritto.
- (5) Sono ammesse consegne parziali.
- (6) Il nostro obbligo di fornitura è sospeso dal momento in cui il cliente risulta inadempiente agli obblighi presi.
- (7) In caso di commesse in conto lavoro, il cliente è tenuto a fornirci tutto il materiale e le documentazioni tecniche necessarie per la fornitura nei dovuti tempi e a proprie spese. Il materiale deve essere perfetto e rispettare i valori specifici indicati e possedere i sovrametalli normali nel settore. Il cliente si assume la responsabilità per le condizioni di garanzia e qualità del materiale fornitoci in conto lavoro. Si accolla inoltre i costi e le eventuali perdite aggiuntive sostenute da Mecc.AI a causa di materiale non avente le dovute caratteristiche tecniche e di qualità garantite.

### Sezione 3 - prezzi, termini e condizioni di pagamento

- (1) I prezzi applicati, se non diversamente specificato per iscritto in quotazione o conferma d'ordine, sono da intendersi franco fabbrica, escludendo gli altri costi di spedizione e di trasporto. Se la consegna è concordata con incluso il trasporto, i prezzi indicati da noi relativi al trasporto stesso si basano sulle spese e le altre variabili pertinenti in vigore al momento della quotazione. I prezzi potranno di conseguenza variare, a favore o sfavore del cliente, al variare di queste condizioni nel lasso di tempo che intercorre tra la quotazione e la spedizione del materiale ordinato, senza che il cliente abbia alcun diritto di recedere dal contratto per questo motivo.
- (2) Se trascorrono più di quattro mesi tra la firma del contratto e la consegna dei materiali ordinati, senza che sussistano responsabilità da parte di Mecc.AI per il ritardo nella consegna, il prezzo dei materiali ordinati potrà aumentare a seconda del caso prendendo in considerazione i costi della materia prima, gli stipendi ed eventuali altri costi accessori sostenuti da Mecc.AI in questo lasso di tempo. Se il prezzo di acquisto aumenta di oltre il 30%, il cliente ha il diritto di recedere dal contratto.
- (3) Se dovessero pervenire richieste di modifica ai materiali ordinati da parte del cliente, i costi aggiuntivi sostenuti a seguito di queste modifiche verranno addebitati e fatturati al cliente.
- (4) Le nostre fatture devono essere saldate per intero in base alle condizioni contrattuali di pagamento concordate tra le parti ed indicate in fattura.
- (5) Se il cliente supera la data di pagamento concordata, Mecc.AI si riserva il diritto di pretendere interessi passivi pari a 8 punti % superiori al tasso bancario in vigore in quel momento.
- (6) Se l'acquirente è in ritardo sul pagamento e presunti giustificati dubbi sulla sua capacità di pagare la somma di nostra proprietà a titolo di credito diventano evidenti, Mecc.AI, indipendentemente da altri nostri diritti, è autorizzata ad esigere il pagamento in anticipo per ulteriori nuove consegne allo scopo di rendere tutti i nostri crediti derivanti dal rapporto commerciale pagabili immediatamente.

### Sezione 4 - Spedizione

Il carico dei materiali ordinati e la spedizione degli stessi sono effettuati senza assicurazione e a rischio del destinatario. Eventuali costi aggiuntivi derivanti da condizioni particolari non preventivamente concordate saranno a carico del compratore - anche se i termini di consegna concordati includono il trasporto.

### Sezione 5 - Termini di consegna

- (1) La definizione dei tempi di consegna deve essere considerata non vincolante per Mecc.AI. La

produzione deve essere comunque eseguita al meglio delle nostre conoscenze e competenze e può essere prolungata a seconda dei casi, in particolare nel caso in cui l'acquirente si astenga dal fornire la sua necessaria e concordata assistenza. Lo stesso vale per le misure adottate in risposta alle loro controversie, in particolare nel caso in cui eventi imprevisi fuori dal nostro controllo dovessero verificarsi; scioperi e serrate, ritardi nelle consegne di componenti da un nostro fornitore, imprevisi derivanti dal trasporto e da interruzioni operative, carenza di materia prima, interruzioni di corrente, ecc.

- (2) Modifiche fatte ai materiali ordinati su specifica richiesta del cliente generano di conseguenza un congruo posticipo della data di consegna concordata.

### Sezione 6 - trasferimento del rischio

(1) Il rischio di perdita accidentale o deterioramento del materiale ordinato passa al cliente non appena il materiale stesso viene prodotto e ne viene data comunicazione al cliente.

### Sezione 7 - Riserva di proprietà

- (1) Ci riserviamo il titolo di proprietà delle merci fornite fino a quando non sia stato effettuato il loro pagamento per intero. La riserva di proprietà si applica anche su tutti i crediti esistenti nel rapporto tra noi ed il cliente, compresi quelli pertinenti a materiali oggetto di reclamo, sino a che le controversie non siano dichiarate risolte ed il pagamento dei materiali oggetto di reclamo sia effettuato per intero.
- (2) Il cliente non è autorizzato a vendere o disporre in alcuna maniera del materiale oggetto dalla fattura di vendita non pagata, compreso cederlo in garanzia a terzi. Non è altresì autorizzato a rivendere tale materiale nel contesto di una propria transazione commerciale. Qualsiasi procedura esecutiva promossa da terzi che abbia per oggetto i materiali deve essere immediatamente portata a conoscenza di Mecc.AI.
- (3) In osservanza del diritto di proprietà come sopra previsto a favore di Mecc.AI, il cliente deve astenersi dal porre in essere atti o comportamenti tali da impedire a Mecc.AI il valido esercizio di tale diritto.
- (4) In caso di violazione dell'obbligazione del cliente come prevista dal presente articolo, Mecc.AI ha il diritto di revocare con effetto immediato tutti gli ordini dei materiali non ancora prodotti.

### Sezione 8 - reclami in garanzia

- (1) In concomitanza con una transazione commerciale tra le due parti nel contesto del contratto, il cliente deve ispezionare il materiale immediatamente al momento della consegna, intendendo che ciò sia utile e funzionale al buon andamento della transazione. Nel caso venga riscontrato un difetto nei materiali forniti, il cliente ha l'obbligo di comunicarlo a Mecc.AI entro 8 giorni dal ricevimento dei materiali stessi. In assenza di comunicazione, il materiale viene considerato accettato, a meno che non si tratti di un difetto che non avrebbe potuto essere identificato durante l'ispezione iniziale.
  - (2) Nella misura in cui i beni hanno un difetto per il quale Mecc.AI è ritenuta responsabile, e il cliente ha notificato il difetto per iscritto in tempo utile, Mecc.AI si impegna a porre rimedio alla situazione ( ed il cliente non ha il diritto di recedere dal contratto o ridurre il prezzo di acquisto ) a meno che non venga espressamente dichiarato da Mecc.AI di rifiutare di porre rimedio a difetto sulla base delle norme di legge. Il cliente dovrà comunque concederci un ragionevole periodo di tempo per porre rimedio ad ogni difetto riscontrato. I materiali contestati possono essere altresì sostituiti con la fornitura di nuovi. Il prezzo di acquisto non può essere ridotto né può il cliente recedere dal contratto, mentre una azione di rimedio da parte di Mecc.AI è in corso.
  - (3) I diritti di garanzia vanno in prescrizione un anno dopo che le merci sono state consegnate.
- Prezzi:  
I prezzi indicati nel listino Special Profiles sono in euro e non comprendono l'IVA. La fatturazione avviene al pezzo.

### Confezioni di vendita

- 10 pz. su tutto, 5 pz. su lamiera, 6 pz. su ferro.

### Sconfezionamento

- Maggiorazione del 10% sul listino in vigore.

### Ordini

Specificare SEMPRE nei Vostri ordini l'unità di misura relativa alle quantità indicate. In mancanza di essa, verranno SEMPRE considerata in PEZZI.

### Consegne

Dal pronto. Successive spedizioni parziali per mancanza di merce saranno in porto franco, purché l'importo sia superiore al minimo evadibile.

### Reso merce:

I resi verranno accettati solo previa compilazione del modulo apposito e successiva autorizzazione da parte di Special Profiles.

### Special Profiles a brand of Mecc.AI Group

Via dei Laghi, 4 - Calcinelli 61036 Colli al Metauro (PU) - Italia  
Tel. +39.0721.8764.206  
www.special-profiles.com



## Section 1 - General Conditions

- 1) The following general terms and conditions of contract apply for all goods and services provided to a specific job order, a legal person governed by public law or of a special fund under public law.
- (2) If a customer has different terms and conditions of sale than ours, and these the latter have not been explicitly recognized to them, they are to be considered not binding on Mecc.AI, even if not explicitly rejected.
- (3) The acquisition and interpretation of these terms and conditions of sale Generals must be exclusively governed by Italian law, as well as the conclusion and interpretation of legal stores with the client. The application of the United Nations Sales Act (CISG) is expressly rejected.
- (4) The nullity of individual provisions or elements of these terms and conditions of General sales do not affect the validity of the remaining provisions.
- (5) The place of performance for obligations created directly or indirectly from the contractual relationship, including the obligation to make the payment, will be the our corporate headquarters.
- (6) The exclusive place of jurisdiction is the one where our company headquarters are located.

## Section 2 - Quotes, scope of performance and conclusion of the contract

- (1) Our quotes generated and relevant to a specific contract are subject to possible changes without notice. Orders are binding on us only to the extent that they are confirmed. Any kind of different arrangement minutes are to be considered valid only if confirmed in writing.
- (2) Our order confirmation has the only value of defining the typology of the contractually due services.
- (3) We reserve the right to modify the design, the choice of materials, the specifications of the same and the method of construction, even after being sent to customer of the order confirmation, provided that these changes are not in contradiction neither with the order confirmation nor with the customer's specifications.
- (4) The documents on which the quote or order confirmation are based, such as diagrams and drawings, dimensions and weight declarations are, as a rule, only approximations and therefore are not binding, as long as not expressly declared in writing.
- (5) Partial deliveries are allowed.
- (6) Our supply obligation is suspended from the moment the customer appears breach of obligations.
- (7) In the case of subcontracting orders, the customer is obliged to provide us with all material and technical documentation necessary for the delivery in due times and own expense. The material must be perfect and respect the values specific indicated and possess the normal allowances in the sector. The customer assumes the responsibility for the conditions of guarantee and quality of the material supplied to us on account work. It also takes over the costs and any additional losses incurred by Mecc.AI because of material that does not have the necessary technical and quality characteristics Guaranteed.

## Section 3 - prices, terms and conditions of payment

- (1) The prices applied, unless otherwise specified in writing in the quotation or order confirmation, are to be understood ex works, excluding the other costs of shipping and transportation. If the delivery is agreed with including transportation, the prices indicated by us relating to the transport itself are based on expenses and others relevant variables in effect at the time of listing. Prices will be able to consequently vary, in favor or disadvantage of the customer, as these conditions vary in the time that elapses between the quotation and the shipment of the material ordered, without the customer having any right to withdraw from the contract for this reason.
- (2) If more than four months elapse between the signing of the contract and the delivery of the materials ordered, without any liability on the part of Mecc.AI for the delay in delivery, the price of the materials ordered may increase depending of the case taking into consideration the costs of the raw material, the wages and any other ancillary costs incurred by Mecc.AI during this period. If the purchase price increases by more than 30%, the customer has the right to withdraw from contract.
- (3) If requests for modification to the materials ordered by the customer, additional costs incurred as a result of these changes will be charged and billed to the customer.
- (4) Our invoices must be paid in full according to the conditions payment agreements agreed between the parties and indicated on the invoice.
- (5) If the customer exceeds the agreed payment date, Mecc.AI reserves the right to claim interest expense equal to 8% points higher than the current bank rate in that moment.
- (6) If the buyer is late on the payment and suspected justified doubts about the his ability to pay the sum of our property by way of credit become evident, Mecc.AI, independently of our other rights, is authorized to demand payment in advance for further new deliveries for the purpose of making all our trade credit claims payable immediately.

## Section 4 - Shipping

The loading of the ordered materials and their shipment are carried out without insurance and at the risk of the recipient. Any additional costs resulting from conditions details not previously agreed will be paid by the buyer - even if the agreed delivery terms include transportation.

## Section 5 - Delivery terms

- (1) The definition of delivery times must be considered non-binding for Mecc.AI. The production must however be performed to the best of our knowledge and skills and can be prolonged as appropriate, particularly in the in the event that the buyer refrains from providing his necessary and agreed assistance.

The same applies to the measures taken in response to their disputes, in particular in the event that unforeseen events beyond our control should occur; strikes e lockouts, delays in deliveries of components from one of our suppliers, unforeseen incidents from transport and operational interruptions, shortage of raw materials, interruptions of current, etc.

- (2) Modifications made to the materials ordered upon specific customer request generate consequently a reasonable postponement of the agreed delivery date.

## Section 6 - transfer of risk

- (1) The risk of accidental loss or deterioration of the ordered material it passes to the customer as soon as the material itself is produced and it is communicated to the client.

## Section 7 - Retention of title

- (1) We reserve the title to the goods supplied until it has been paid in full. The retention of title also applies to everyone the credits existing in the relationship between us and the customer, including those pertinent to materials object of complaint, until disputes are declared resolved and payment of the materials subject to complaint is made in full.
- (2) The customer is not authorized to sell or dispose of the in any way material covered by the unpaid sales invoice, including transferring it as guarantee to third parties. It is also not authorized to resell such material in the context of a own commercial transaction. Any executive procedure promoted by third parties who have as their object the materials must be immediately brought to knowledge of Mecc.AI.
- (3) In compliance with the property right as provided above in favor of Mecc.AI, the customer must refrain from engaging in acts or conduct that would prevent a Mecc.AI the valid exercise of this right.
- (4) In case of violation of the client's obligation as provided for in this article, Mecc.AI has the right to revoke all orders from materials not yet produced.

## Section 8 - warranty claims

- (1) In conjunction with a commercial transaction between the two parties in the context of the contract, the customer must inspect the material immediately at the time of delivery, meaning that this is useful and functional to the good performance of the transaction. If a defect is found in the materials supplied, the customer has the obligation to communicate it to Mecc.AI within 8 days of receipt of the materials themselves. In the absence of communication, the material is considered accepted, unless that it is not a defect that could not have been identified during the initial inspection.
- (2) To the extent that the goods have a defect for which Mecc.AI is held responsible, and the customer has notified the defect in writing in good time, Mecc.AI undertakes to remedy the situation (and the customer has no right to withdraw from the contract or reduce the purchase price) unless it comes expressly declared by Mecc.AI to refuse to remedy a defect on the basis of the law. The customer will still have to give us a reasonable period of time to remedy any defect found. The materials disputed can also be replaced with the supply of new ones. The price of purchase cannot be reduced nor can the customer withdraw from the contract while a remedial action by Mecc.AI is in progress.
- (3) Warranty claims become time-barred one year after the goods have been delivered.

## Prices

Prices in Special Profiles price list are in euro, without VAT. Invoicing by piece.

## Sales packaging

- 10 pcs. over all, 5 pcs. on sheets, 6 pcs. on iron.

## Unpack

- 10% surcharge on the current price list.

## Orders

ALWAYS specify in your orders the unit of measurement relating to the indicated quantities. In absence of it, they will ALWAYS be considered in PIECES.

## Deliveries

From stock. Subsequent partial shipments for lack of goods will be free delivered provided that the amount is greater than the minimum executable amount.

## Returned goods

Returns will be accepted only after completing the appropriate form and subsequent authorization by Special Profiles.

## Special Profiles a brand of Mecc.AI Group

Via dei Laghi, 4 - Calcinelli 61036 Colli al Metauro (PU) - Italy  
Tel. +39.0721.8764.206  
[www.special-profiles.com](http://www.special-profiles.com)

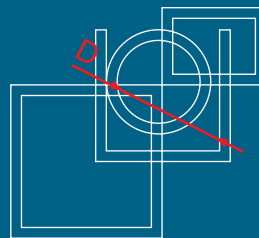

## SPECIAL PROFILES

by **MECC.AL. Srl**

Via dei Laghi, 4 - Calcinelli 61036

Colli al Metauro - PU - Italy

Tel: + 39 0721 876 4201 (IT)

Tel: + 39 0721 876 4206 (EN)

[specialprofiles@meccal.com](mailto:specialprofiles@meccal.com)



[www.special-profiles.com](http://www.special-profiles.com)